

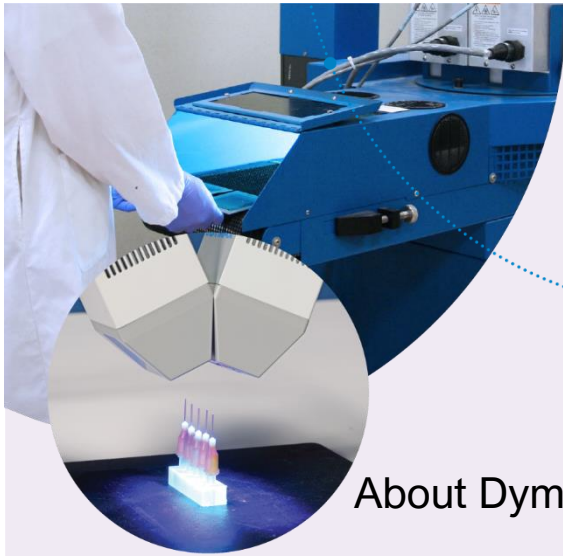

BlueWave[®] QX4

Multi-Head LED Spot Lamp System User Guide





About Dymax

Light-curable adhesives. Systems for light curing, fluid dispensing, and fluid packaging.

Dymax manufactures industrial adhesives, light-curable adhesives, epoxy resins, cyanoacrylates, and activator-cured adhesives. We also manufacture a complete line of manual fluid dispensing systems, automatic dispensing systems, and light-curing systems. Light-curing systems include LED light sources, spot, flood, and conveyor systems designed for compatibility and high performance with Dymax adhesives.

Dymax adhesives and light-curing systems optimize the speed of automated assembly, allow for in-line inspection, and increase throughput. System designs enable stand-alone configuration or integration into your existing assembly line. Please note that most dispensing and curing system applications are unique. Dymax does not warrant the fitness of the product for the intended application. Any warranty applicable to the product, its application, and use is strictly limited to that contained in the Dymax standard Conditions of Sale. Dymax recommends that any intended application be evaluated and tested by the user to ensure that desired performance criteria are satisfied. Dymax is willing to assist users in their performance testing and evaluation. Data sheets are available for valve controllers or pressure pots upon request.

Contents

Introduction	5
Intended Audience	5
Where to Get Help.....	5
Safety	5
General Safety Considerations	6
Specific Safety Considerations.....	6
Dymax UV Light-Curing System Safety Considerations	7
Product Overview	9
Description of the BlueWave QX4.....	9
Features & Benefits.....	10
Validation	12
Front Control Panel.....	13
Back Panel.....	14
Unpacking	15
Parts Included	15
System Setup	15
System Connections	15
LED Heads & Lenses	16
Constant Mode.....	19
Variable Mode	21
PLC Operation	25
4-Channel Mode	32
Controller Set Up.....	32
I/O Connection.....	32
System Settings	36
Setting the Language.....	36
Sound Settings	37
Temperature Warning Settings.....	38

Intensity Control Feature	39
Cleaning & Maintenance	39
LED Head Optic Lens	39
Error Codes & Troubleshooting	40
Error Codes	40
Spare Parts and Accessories	42
Specifications	43
Declaration of Conformity	45
Warranty	46
Index	47

Introduction

This guide describes how to set up, use, and maintain the BlueWave® QX4 LED Spot-Curing System safely and efficiently.

Intended Audience

Dymax prepared this user guide for experienced process engineers, technicians, and manufacturing personnel. If you are new to high-intensity LED light sources and do not understand the instructions, contact Dymax Application Engineering for answers to your questions before using the equipment.

Where to Get Help

Dymax Customer Support and Application Engineering teams are available by phone in the United States, Monday through Friday, from 8:00 a.m. to 5:30 p.m. Eastern Standard Time. You can also email Dymax at info@dymax.com. Contact information for additional Dymax locations can be found on the back cover of this user guide.

Additional resources are available to ensure a trouble-free experience with our products:

- Detailed product information on www.dymax.com
- Dymax adhesive product data sheets (PDS) on our website
- Material safety data sheets (SDS) provided with shipments of Dymax adhesives

Safety



WARNINGS! *If you use this LED light source without first reading and understanding the information in this user guide, injury can result from exposure to high-intensity light. To reduce the risk of injury, read and ensure you understand the information in this user guide before assembling and operating the Dymax LED light source.*

To use the BlueWave QX4 system safely, it must be set up and operated in accordance with the instructions given by Dymax. Using the system in any other manner will impair the protection of the system. Dymax assumes no liability for any changes that may impair the protection of the BlueWave QX4 system.

General Safety Considerations

All users of Dymax LED light sources should read and understand this user guide before assembling and using the system.

To learn about the safe handling and use of light-curable formulations, obtain and read the SDS for each product. Dymax includes an SDS with each adhesive sold. In addition, fluid product SDS are available on our website.

Specific Safety Considerations

The BlueWave QX4 is designed to maximize operator safety and minimize exposure to light-curing energy. To use the unit safely, it must be set up and operated in accordance with the instructions in this user guide. Please also read and understand the safety considerations unique to LED-curing systems as described below.



WARNINGS! *Looking directly at the high-intensity light emitted by the heads of the BlueWave QX4 can result in eye injury. To prevent eye injury, never look directly at the end of the high-intensity head and always wear protective goggles. To avoid accidental exposure, always point the LED head away and at the curing substrate.*

This device falls under IEC 62471 Risk Group 3 for UVA and blue light emissions:

WARNING! *UV emitted from this product. Avoid eye and skin exposure to unshielded products.*

WARNING! *Possibly hazardous optical radiation emitted from this product. Do not look at operating lamp. Eye injury may result.*

Removing the cover from the BlueWave QX4 controller may result in electrical shock. To prevent the possibility of an electrical shock, never remove the controller's cover

The controller is cooled by natural convection. If you block the air flow from the controller, equipment damage and malfunction can result. To prevent damage and malfunction, ensure adequate space around controller vents to allow the free flow of air. Typically, 1.5 in of space around all sides of the controller is sufficient.

Dymax UV Light-Curing System Safety Considerations

Operators must understand these three concepts to use the LED light source safely: UV exposure, high-temperature surfaces, and bright, visible light.

UV Exposure

Figure 1.
UV Spectrum

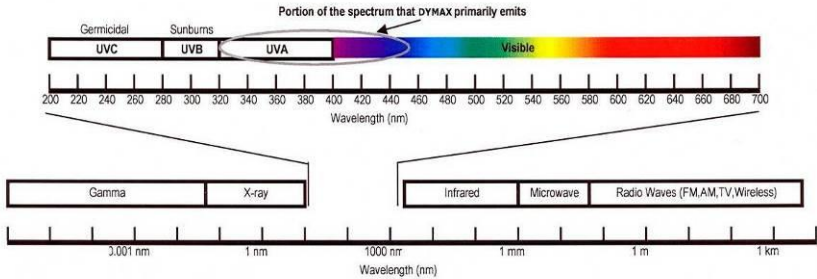

Standard Dymax UV light-curing systems have been designed primarily to emit UVA and Visible energy (Figure 1). Depending on the type of LED head used, the energy emitted from the BlueWave QX4 can either be in the upper end of the UVA portion of the spectrum (PrimeCure® & RediCure®) or in the lower portion of the visible spectrum (VisiCure®). UVA energy is generally considered the safest of the three UV ranges: UVA, UVB, and UVC. Although OSHA does not currently regulate UV-light exposure in the workplace, the American Conference of Governmental Industrial Hygienists (ACGIH) does recommend Threshold Limit Values (TLVs) for ultraviolet light.

The strictest interpretation of the TLV (over the UVA range) for workers' eyes and skin allows continuous exposure up to 1 mW/cm² (intensity). Unless you are placing bare hands into the curing area, it is unusual to exceed these limits. To put 1 mW/cm² limit into perspective, a cloudless summer day will typically exceed 3 mW/cm² of UVA light, and also include the more dangerous UVB light (primarily responsible for sun tans, sun burns, and skin cancer).

Checking the Workstation

The human eye cannot detect "pure" UV light, only visible light. A radiometer should be used to measure stray UV light to confirm the safety of a UV light-curing process. A workstation that exposes an operator to more than 1 mW/cm² of UVA continuously should be redesigned.

Protecting Operators

Light-curing technology can be a regulatory compliant, "worker-friendly" manufacturing process when the proper safety equipment and operator training is utilized. There are two ways to protect operators from UV exposure: shield the operator and/or shield the source.

Shield the Operator

UV-Blocking Eye Protection — UV-blocking eye protection is recommended when operating UV light-curing systems. Both clear and tinted UV-blocking eye protection is available from Dymax.

UV-Blocking Skin Protection — Opaque, UV-blocking clothing, gloves, and full-face shields are recommended when skin may potentially be exposed to UV light.

Shield the Source of UV

Any substrate that blocks UV light can be used as a shield to protect workers. The following materials can be used to create simple shielding structures:

Rigid Plastic Film — Transparent or translucent/UV-blocking plastics (typically polycarbonate or acrylic) are commonly used to create shielding where some level of transparency is also desired.

Flexible Film — Translucent UV-blocking, flexible urethane films can be used to quickly create workstation shielding. This UV-blocking, flexible urethane film is available from Dymax, call for assistance.

High-Temperature Surfaces

Surfaces exposed to high-intensity curing lights may rise in temperature. The intensity, distance, exposure time, cooling fans, and composition of the surface can all affect the rise in surface temperature. In some cases, exposed surfaces

can reach temperatures capable of producing a burn or causing damage to a substrate. In these cases, care must be taken to ensure either a more moderate surface temperature or appropriate protection/training for operators. No infrared radiation is produced by these LED systems, so surface temperatures will be lower than with conventional lamp systems. Empirical testing should be used to verify the exact temperature rise in each application.

Bright Visible Light

The bright visible light energy emitted by curing systems can cause eyestrain if proper eye protection or shielding is not used. The use of tinted eye protection and/or opaque/ tinted shielding can be utilized to reduce eyestrain and address this concern.

Product Overview

Description of the BlueWave QX4

The BlueWave QX4 high-intensity spot-curing system features all the benefits of LED-curing technology in a smaller, more versatile unit. This system is comprised of a power supply, a controller with an easy-to-use control interface, and up to four LED heads. LED heads are available in 365, 385, and 405 nm and can be outfitted with 3-, 5-, or 8-mm diameter focusing lenses. LED heads and focusing lenses can be used in any combination and can be operated in constant or variable mode.

The system's LED heads can be used as hand-held units or integrated into an automated manufacturing system allowing for maximum application flexibility. Their output intensity levels can also be adjusted from 10% to 100% to meet process and adhesive requirements. The BlueWave QX4 is rated for continuous operation. However, if the internal temperature of the system exceeds the maximum safe operating temperature limits, each LED head contains a thermal sensor that will shut the unit down to protect the components of the head.

Figure 2.
Main Components of a BlueWave QX4

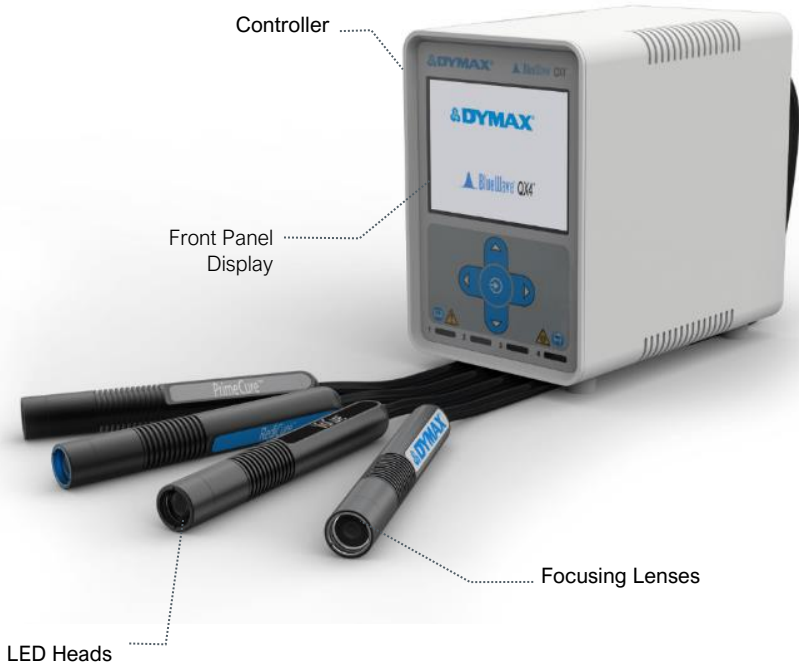

Features & Benefits

The Dymax BlueWave QX4 is engineered for precise performance and long service life. Key features include:

Features	Benefits
One controller controls up to four LED heads	<ul style="list-style-type: none">• Provides maximum application flexibility
LED heads available in 365, 385, or 405 nm wavelengths	<ul style="list-style-type: none">• Compatible with a variety of UV and visible light-curable materials• Wavelength flexibility allows co-optimization of adhesive and curing system for optimal cure• Units can be custom configured to your curing requirements
Variable mode allows each LED head to be programmed independently	<ul style="list-style-type: none">• Individual exposure times and intensity settings available in 1% increments for each LED head allows for maximum curing flexibility
Interchangeable/Replaceable focusing lenses in 3-, 5-, and 8-mm diameters	<ul style="list-style-type: none">• Allows tailoring of the unit to your curing requirements
Instant on-off	<ul style="list-style-type: none">• No warm-up period• More energy efficient
Efficient LED-head temperature management	<ul style="list-style-type: none">• Maximized continuous operation without overheating• Comfortable hand-held operating temperature• Temperature monitoring assures maximum LED life
Programmable Logic Control (PLC) interface with 4-channel mode	<ul style="list-style-type: none">• Easily incorporated into automated systems• Allows the four LED heads to be operated and activated independently in PLC mode

Validation

Tests should be conducted prior to production to determine the time and light intensity required to fully cure your resin. The following approaches may be used to validate the curing process.

Set Exposure Time, Determine Intensity

Users can specify a cure time and, through empirical testing, determine the intensity required to achieve a full cure. As with any manufacturing process, it is advisable to incorporate a safety factor.

Set Intensity, Determine Exposure Time

Users can specify light intensity and, through empirical testing, determine the exposure time required to achieve a full cure. As with any manufacturing process, it is advisable to incorporate a safety factor.

Control

Process validation confirms a minimum acceptable intensity. Users can then choose to operate at full intensity (using the excess intensity as an additional safety factor) or adjust the output to a specific intensity level. To ensure consistent and repeatable process results, intensity levels should be monitored with a radiometer. This enables users to identify light intensity changes and take corrective action (either adjusting the light intensity or performing maintenance).

Front Control Panel

- **Front Control Panel Display** — Displays the currently selected menu.
- **Up Button (▲)** — Navigates the selector up one position. It is also used to increase the selection value.
- **Down Button (▼)** — Navigates the selector down one position. It is also used to decrease the selection value.
- **Right Button (▶)** — Selects the highlighted option and advances the screen to the next menu.
- **Left Button (◀)** — Navigates to the previous menu. Holding this button down for more than one second will return you back to the main menu. It can also be used to cancel a selected option and return to the previous menu.
- **Run Button (⌂)** — Activates the irradiation when the run option is selected. This button is also used as an enter button.
- **LED Head Indicators** — Colored lights indicate the status of each connected head. A green light indicates that a head is active. An orange light indicates an over-temperature warning. A red light indicates that the critical temperature has been exceeded.

Figure 3.
Front Control Panel



Back Panel

- **Power Cord Receptacle** — Connection point for the power cord.
- **On/Off (I/O) Switch** — Moving the switch to the on position (I) powers up the controller. Moving the switch to the off position (O) cuts power to the controller.
- **Footswitch Jack** — Connection point for the footswitch. Pressing the footswitch starts a curing cycle. In timed operation, pressing and releasing the footswitch initiates the curing cycle. A second press will terminate a timed cure cycle immediately.
- **PLC Connector Terminals** — Connection points for an interface with a user-supplied PLC (for remote operation).
- **RS232** — The RS232 port is a Dymax applicable troubleshooting port. No user functionality is available at this time.
- **LED Head Connectors** — Connection points for up to four LED heads. Each connector corresponds to an available channel and indicator on the front panel.

Figure 4.
Back Panel Controls & Connections

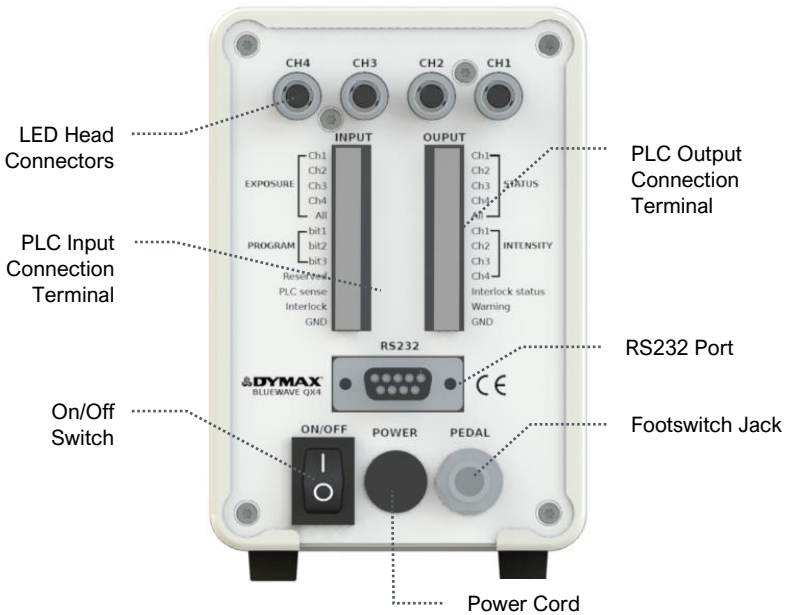

Unpacking

Upon arrival, inspect all boxes for damage and notify the shipper of box damage immediately. Open each box and check for equipment damage. If parts are damaged, notify the shipper and submit a claim for the damaged parts. Contact Dymax so that new parts can be shipped to you immediately.

Check that the parts included in your order match those listed below. If parts are missing, contact your local Dymax representative or Dymax Customer Support to resolve the problem.

Parts Included

Controller

- Controller Base
- Power Adapter
- Power Cord
- Foot Switch
- Safety Glasses
- BlueWave QX4 User Guide

LED Heads

- LED Head Assembly
- Accessory Focusing Lenses
- PLC Connection Terminals
- Extra connection cable extensions can be ordered as accessories

System Setup

System Connections

Power Cable Connection — Attach the Power Cord to the Power Cord Receptacle located on the unit's back panel (Figure 4). The **flat** portion of the connector body should be pointing **up**. Press the Power Cord firmly into the receptacle until it **clicks** and locks into place. The unit is now powered and ready to be turned on with the On/Off Switch.

To remove the Power Cord, pull the retaining body of the Connector to unlock it from the receptacle.

LED Head Connection Jacks — Along the top of the Controller's Rear Panel, there are four LED Head Connection Jacks labeled CH 1 - 4. The Connectors are keyed so they may require slight rotation to align with the keying elements of the connector pair.

Once the keyways are aligned press the LED Head Connector into the jack until it clicks and locks in place.

NOTE: DO NOT rotate the connectors once installed, they are not threaded, and damage may occur.

To remove the LED Head, grasp the metal Outer Retaining Ring Body of the Connector and pull away from the Controller to unlock it from the Jack.

Footswitch Connection — Located on the rear panel of the Controller. It can be used as an optional irradiation trigger.

PLC Connection Terminals — There are input and output PLC Connection Terminals that can be used to integrate the unit to an automated assembly line. See the *PLC operation Section* for more details.

When the PLC sense connection has a low signal, the Front Screen will display the PLC connection and will lock out the buttons on the Front Control Display. A low signal on the interlock connection will lock out the unit.

LED Heads & Lenses

The BlueWave QX4 led heads are available in three different wavelengths: 365 nm (RediCure), 385 nm (PrimeCure), and 405 nm (VisiCure). Each LED head is made up of three main components: the handle, a collimating lens, and a spot lens. LED head assemblies are 1.0 M in length. Extensions can be purchased for extra length. Extension cables can be used for up to 3 M additional length in any combinations.

Figure 5.
LED Head Components

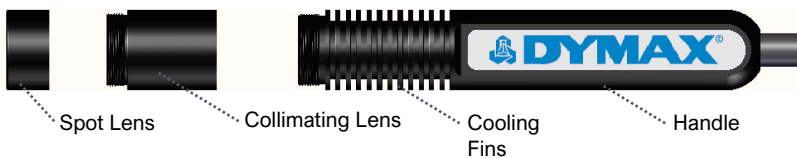

The handle indicates the wavelength with a type label. The collimating and focusing lenses in each head are interchangeable, but the handle is unique to a specific wavelength.

Figure 6.
Color-Coded LED Heads



Figure 7.
Focus Lenses



The focusing lenses indicate the spot size that is generated at a 5-mm working distance. The UV energy is focused on that spot and provide maximum output and uniformity of the spot.

As you change working distance the intensity and spot size will change, and it is best to review the product bulletin to ensure you are using the correct lens and working distance combination to achieve the target exposure.

If you are using larger working distances you may have best results removing the focusing lens and just using the collimating lens for spot generation.

Fixturing

If fixturing the LED head, do not cover the cooling fins or overheating can result. We suggest clamping on the flat portion of the handle with non-marring screws or split ring clamps.

Figure 8.
Fixturing Recommendations

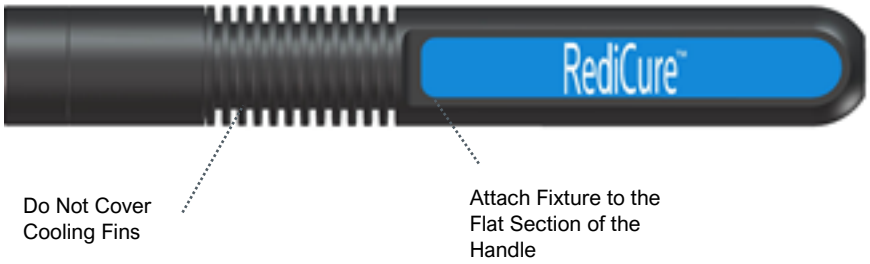

Operation



WARNING! Looking directly at the high-intensity light emitted by the heads of the BlueWave QX4 can result in eye injury. To prevent eye injury, never look directly at the high-intensity light and always wear protective goggles (provided).

Verify that all connectors are firmly plugged into the rear panel of the unit. See *System Connections*, pg. 15 for more details.

On the rear panel of the controller, move the Power Switch to the on position (I). The system is now ready for use.

Upon startup of the unit, the main menu screen should appear in the display. The main menu displays the two working modes of the unit as well as the system settings. Hold down the left button for longer than one second to bring the display back to the main menu page.

Constant Mode

Constant mode allows the user to configure each head at a predefined (constant) power output for a given amount of time. Each head can be adjusted independently of each other.

To enter constant mode, use the up and down buttons to highlight constant mode on the main menu screen. Press the right button to enter.

Figure 9.
Main Menu Screen

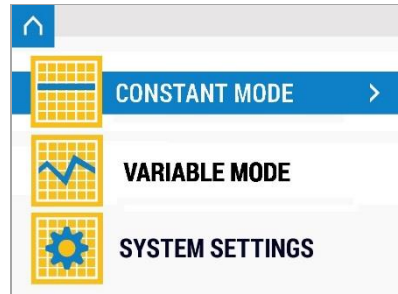
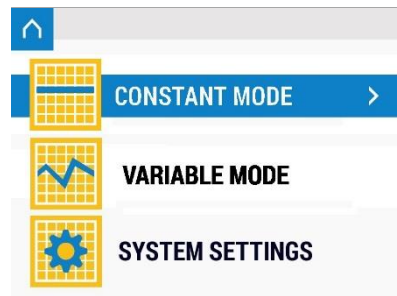

Figure 10.
Select Constant Mode



Set Up

In the constant mode menu, the user can see the current power and time configuration for each one of the LED Heads. To update any LED Head, navigate to the LED Head using the up and down buttons. The selected option will be highlighted in green. Press the right button to edit. Any LED Head that is not connected will appear grayed out. The user can still select and program any grayed-out rows, but the unit will not run the program for the disconnected LED Head.

Another screen will show the power and time (Figure 12). To change the power, press the run button (Figure 13). The number will start blinking. Use the up and down buttons to modify the value. Press the run button again to set. The power can be set from a value of 10-100%, at 1% increments. To edit the time, navigate to it using the Down button. Press the run button (Figure 13) to edit. Use the up and down buttons to change the value, then press the run button again to set. The maximum time setting is 999 seconds. To turn off an LED Head, set the power or time setting to 0. Pressing and holding the up or down buttons will increase/decrease the value at a faster pace.

When editing is finished, press the left button to go back to the constant model menu.

Figure 11.
Constant Mode Menu

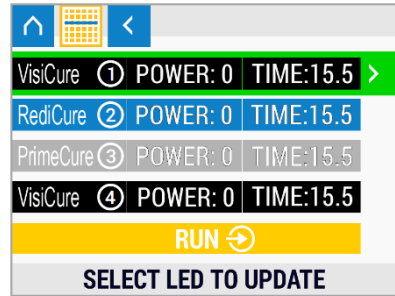

Figure 12.
Power & Time Editing Screen

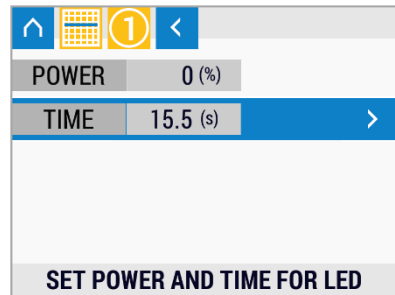
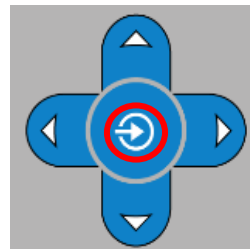

Figure 13.
Run Button



Irradiation

Once all the LED heads have been configured, navigate to the RUN option. Press the run button to start irradiation.

Figure 14.
Select Run Row

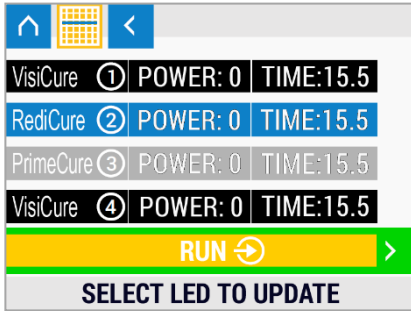
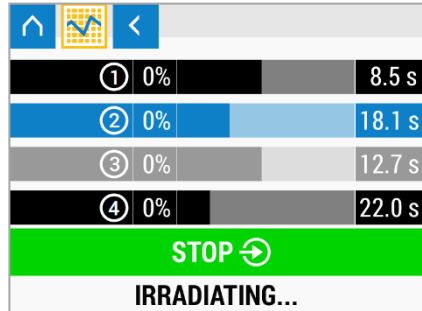

Figure 15.
Screen During Irradiation



During irradiation, the time will count down to indicate the time remaining on the current curing session. Press the run button during an irradiation cycle to stop the irradiation and reset the cycle. The Footswitch can also be used instead of pressing the run button.

An indicator light will show on the bottom of the front display to show which heads are active during the irradiation cycle. A green light shows that the head is active with no faults. An orange indicator light shows that the corresponding head has reached the user-set temperature-warning threshold. The head will continue to function as normal until it reaches a critical temperature condition.

Variable Mode

Variable mode allows the user to set different power profiles in a given time frame for each head. Up to seven different programs can be stored into the unit.

To enter variable mode, navigate using the up/down buttons, then press right button to enter.

Figure 16.
Select Variable Mode

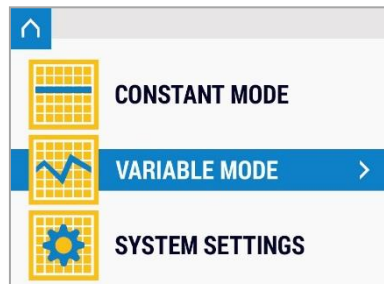

Set Up

On the variable mode menu (Figure 17), the user will see seven programs. Each program is a collection of steps and cycles. The programs are stored in local memory and can be used via the GUI interface or the PLC interface. Each LED Head can be programmed independently of the other LED Heads.

To run or edit a program, navigate using the up and down buttons. Once highlighted, press the Right button to enter.

Figure 17.
Variable Mode Menu

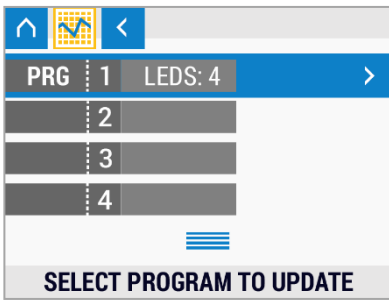
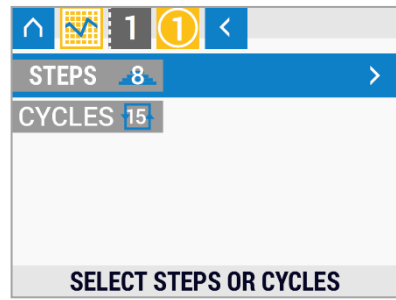

Figure 18.
Program Menu



The program menu (Figure 18) allows the user to see the number of steps and cycles active for each one of the LED Heads in the given program. To edit the configuration of an LED Head, navigate using the up and down buttons, then press the right button to edit. Any LED Head that is not connected will be grayed out on the display. The user can still select and program any grayed out rows, but the unit will not run the program for the disconnected LED Head.

On the edit menu (Figure 19), the user will see the number of steps and cycles currently configured for a head. A step consists of a power configuration for a given amount of time. The collection of steps will repeat for the number of cycles. The user can adjust the number of cycles from 0-99. Setting the number of cycles to 0 will disable the highlighted head.

To edit the steps, navigate using the up and down buttons, then press Right button to edit.

Figure 19.
Edit Menu

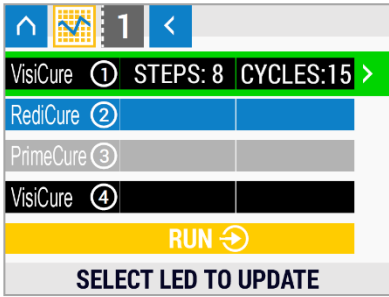
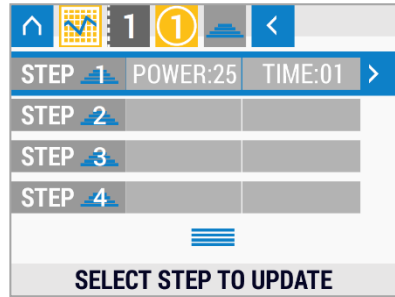

Figure 20.
Steps Menu



On the steps menu (Figure 20), the user can see the power and time settings for each step. To edit the step, navigate using the up and down buttons, then Right button to edit.

In a similar fashion to the constant mode, the power can be adjusted by first pressing the right button. Use the up and down buttons to adjust the power, then the run button to set. Use the up and down buttons to set the time, then press the run button to set. The user can set an “off” step by entering 0% into the power field and setting a time period. Adding an “off” step to the last step in a cycle allows the user to set a “cool down” time or an “off” period for a precise amount of time in between cycles.

Press the left button to go back to the previous menu.

Once the steps are set, the cycles can be adjusted by pressing the right button while highlighting the cycles row (Figure 22). Use the up and down buttons to set the cycles.

Figure 21.
Power Menu

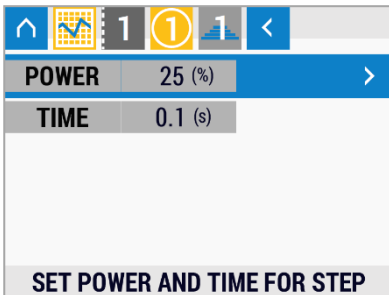
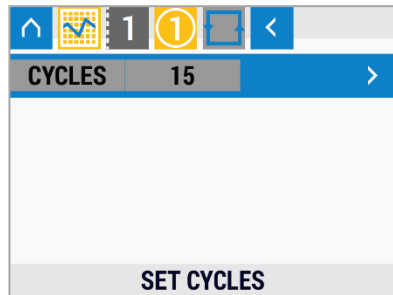

Figure 22.
Adjust Cycles



Irradiation

Once all configurations are ready, navigate to the RUN row (Figure 23) using the up and down buttons. Press the center run button to start irradiation in all LED Heads.

Figure 23.
Select RUN Option

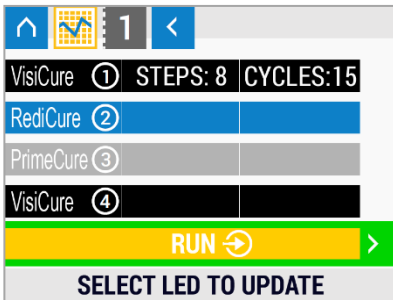
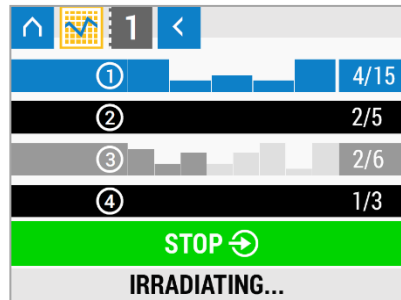

Figure 24.
Irradiation Screen



During irradiation, the steps and cycles will count down to indicate the time remaining on the current curing session. Pressing the center run button during the irradiation cycle will stop the irradiation. The Footswitch can also be used instead of pressing the center run button.

An Indicator Light will show on the bottom of the front panel to show which LED Heads are active during the irradiation cycle. A green light shows that the LED Head is active with no faults. An orange indicator light shows that the corresponding LED Head has reached the user-set temperature-warning setting. The LED Head will continue to function as normal until it reaches a critical temperature condition.

PLC Operation

Programmable logic control (PLC) of the *BlueWave QX4* is achieved through the PLC terminal block connectors. The input connections are separated into two main groups: the exposure connections and the program selection connections. PLC control is achieved via sinking I/O control pins. The unit normally has high logic levels (+5 V) and looks for a low signal (0 V) input. The exposure connections can be used to activate specific heads or all heads simultaneously. The program selection bits determine which program mode the unit will operate in.

PLC operation mode can only be entered by bringing the PLC sense input to a logic (0V). This will lock out the front control panel and will prevent the user from entering any commands using the front buttons. **Programs and run modes must be adjusted prior to entering PLC mode.**

Figure 25.
PLC Mode Screen

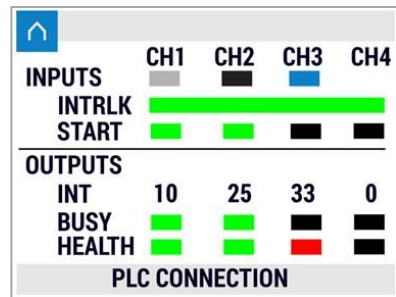
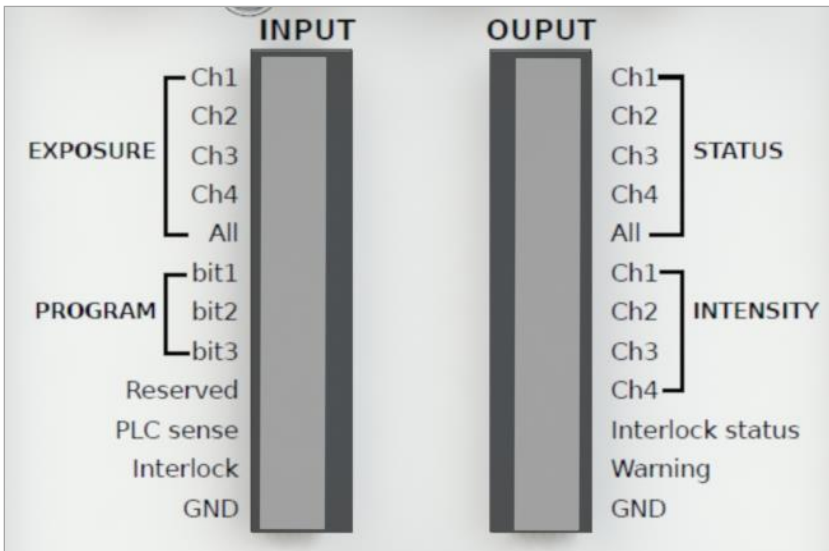

Figure 26.
PLC Inputs & Outputs



PLC Mode Screen

The PLC Mode Screen appears when PLC mode is enabled. The display will provide status information in the form of colored bars.

INPUTS

Along the row of **INPUTS** is the Channel identifiers. Each connected head will be indicated by a colored box.

- For **RediCure** the square is **blue**
- For **PrimeCure** the square is **gray**
- For **VisiCure** the square is **black**
- Head is **disconnected**, the square is **white**

Figure 27.
Channel Identifiers

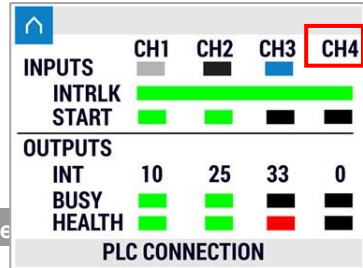

INTRLK

The INTRLK (Interlock) status is shown in a large band.

- **Green** band is Interlock not active
- **Red** band is Interlock active

START

The START status shows channels that are actively irradiating.

- **Green** square is head irradiation active
- **Black** band is head irradiation inactive

OUTPUTS

INT

The number shown for each channel is the commanded intensity value as a percentage of power to the head.

This value is determined by the program setting on the CONSTANT mode screen.

BUSY

The BUSY signal is indicated for head status activity.

- **Green** indicates a busy head either irradiating or has a health issue
- **Black** indicates the head is idle

Figure 28.
Status Indicators

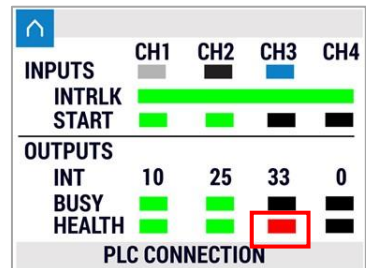

HEALTH

The HEALTH signal is an indication of warning or activity.

- **Green** indicates head is healthy with no warnings and is actively irradiating.
- **Red** indicates the head has an error warning.
- **Black** indicates the head has no error warning and is inactive.

In Figure 29, you will see that all four channels have heads installed and they are RediCure wavelength. The interlock is closed and the LEDs are off.

However, you can see that Channel 1 has an error, Health is red, and Busy shows green.

There is also an error message and icon as well as the status LED on the lower edge of the unit is now Red.

Figure 29.
Example Screen



Inputs

Signal Name/ Description	Asserted	Deasserted
	0V	24V
PLC SENSE	The unit enters PLC mode. The front panel will display the PLC screen. The front panel will be locked. All PLC inputs will be monitored. All PLC Outputs will be active.	The unit enters normal mode. The front panel will be unlocked. All PLC Inputs will be ignored. All PLC Outputs will be inactive.
INTERLOCK	Front panel displays lock screen. Front panel will be locked. All heads will be shut off. All wants will be disabled.	All LED heads will function normally.
EXPOSURE 1->4 (Timed Mode, Duration >0.0 Seconds)	LED head "n" will start its program. LED head "n" must complete its program before another assertion will be recognized.	LED head "n" ready for next assertion
EXPOSURE 1->4 (Manual Mode, Duration = 0.0 Seconds)	LED head "n" will turn on.	LED head "n" will turn off.
EXPOSURE ALL	All LED heads currently not running a program will start their program.	Ready for next assertion.
RESERVED	Not used at this time	
GND	User signal ground	
PROGRAM 1 -> 3	Select current program (Table 1)	

Table 1.
Program Bits

Bit 1	Bit 2	Bit 3	Program Selection
HIGH (1)	HIGH (1)	HIGH (1)	Continuous Mode
HIGH (1)	HIGH (1)	LOW (0)	Program 1
HIGH (1)	LOW (0)	HIGH (1)	Program 2
HIGH (1)	LOW (0)	LOW (0)	Program 3
LOW (0)	HIGH (1)	HIGH (1)	Program 4
LOW (0)	HIGH (1)	LOW (0)	Program 5
LOW (0)	LOW (0)	HIGH (1)	Program 6
LOW (0)	LOW (0)	LOW (0)	Program 7

Outputs

*Output pins require a 10K pull up resistor to customer supplied 24V depending on load, contact Application Engineering for issues related to choosing resistors

Signal Name/ Description	Asserted	Deasserted
	24V	0V
STATUS 1 ->4	LED head "n" is running a program or is currently on.	LED head "n" is not running a program and is currently off.
STATUS ALL	Any LED head is running a program or any LED head is currently on.	No LED head is running a program and all LED heads are currently off.
WARNING	Any LED head is in alarm or the controller is in alarm. Warning screen will be displayed. Front panel will be locked. All LED heads will be turned off. All LED heads will be disabled.	No LED heads or the controller are in alarm.
INTERLOCK STATUS	INTERLOCK Input is asserted.	INTERLOCK Input is de-asserted.
GND	Reference Ground Pin	
INTENSITY 1 -> 4	<p>Active Head: PWM-type signal from 0% to 100% duty cycle in 100 hz or 1 KHz</p> <p>Inactive/Error Status Head: Output will reflect head type and can be polled to determine head type directly. RediCure = 20% PWM signal PrimeCure = 40% PWM signal VisiCure = 60% PWM signal</p>	

Figure 30.
PLC Wire Attachment, Terminals Installed

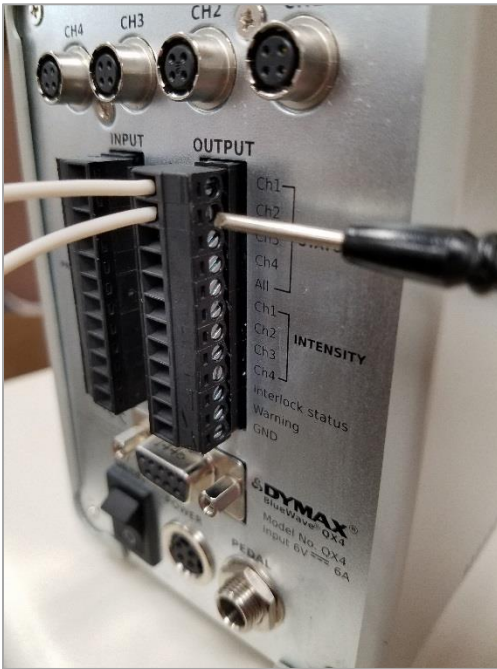

Wiring PLC

When wiring the PLC connectors use wires no larger than 20 AWG. Strip the wire back approximately 8-mm to insert into the connector clamp.

Ensure the connector wire clamp is open by unscrewing the clamp screw if needed and insert the wire. Tighten the clamp screw to lock the wire in place.

4-Channel Mode

The BlueWave QX4 can be run in 4-channel mode through the Input Port on the back panel of the unit. This allows the unit to operate up to four LED heads independently with up to four separate footswitches. Proper connection and interface to external Programmable Logic Controllers will allow for independent and autonomous control of each LED Head channel.

Controller Set Up

In the constant mode menu, set the desired power level and time configuration for each head as explained in the Operations Section of this user manual.

NOTE: Any channels that will use external time control still need to have power set to the desired level and the time set to zero.

Once all applicable LED Head channel programming has been completed, the PLC control can be activated. PLC operation mode is entered by bringing the PLC sense input to a logic (0V). This will lock out the Front Control Panel and will inhibit any Front Panel or Footswitch activity. Programs and run modes must be adjusted prior to entering the PLC mode.

I/O Connection

Inputs

Exposure – The exposure input allows the user to activate any single channel independently or all channels simultaneously.

PLC Sense – A logic (0V) PLC sense signal will activate PLC mode and lock out the front control panel.

Interlock – A logic (0V) signal to the interlock terminal block will act as an emergency shutoff switch.

Figure 31.
PLC Mode Screen

	CH1	CH2	CH3	CH4
INPUTS				
INTRLK	[Green bar]			
START	[Green bar]	[Green bar]	[Black bar]	[Black bar]
OUTPUTS				
INT	10	25	33	0
BUSY	[Green bar]	[Green bar]	[Black bar]	[Black bar]
HEALTH	[Green bar]	[Green bar]	[Red bar]	[Black bar]
PLC CONNECTION				

GND – Ground used to produce a logic (0V) signal.

Figure 32.
PLC Inputs & Outputs

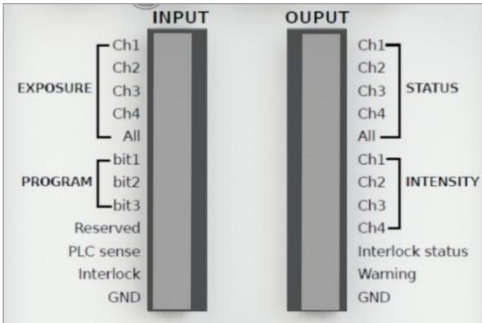

Input Logic

Channel 1/2/3/4 Exposure Control (CH1/2/3/4 Start)

Pulling CH1/2/3/4 pin to LOW (0) for 10mS or more will start irradiation on Head 1/2/3/4 and follow their respective programmed power level and exposure time settings for such head on each channel.

Individual channels programmed to zero exposure time; will activate for the duration that the associated channel pin is kept LOW.

Any additional pulse on CH1/2/3/4 will have no effect before any current exposure cycle time is completed.

All Channel Exposure Control (ALL Start)

Pulling the ALL Pin to LOW (0) for 10 mS or more will start irradiation on all LED Heads. They will run in accordance with the profiles configured on Channels 1, 2, 3, and 4.

Channels programmed to zero exposure time will activate for the duration that the ALL Pin is kept at LOW.

Pulling the ALL Pin to LOW (0) for 10 ms or more will have no effect on any channel set for zero exposure times. Channels will need to be individually activated.

PLC Detect

This pin acts as a detector for a PLC connector. When the pin is driven low, it represents a connector present, the device will enter PLC mode and will ignore any front panel or footswitch input.

Interlock

This pin enables or disables the operation of the device, even when the PLC mode is not active. Setting this pin to LOW (0) will enable all operations on the device, including LCD input and PLC control mode. Setting this pin to HIGH (1) will disable all operations on the device, including stopping any exposure operations currently taking place.

LED Head Channel	Time Set	Input Status	Action	Input Status	Action
1, 2, 3, or 4	0	HI	LED off	LO (GND OV)	LED turns ON and remains ON while input remains LO
1, 2, 3, or 4	>0	HI	LED off	LO	LED turns ON, and stays ON until time expires, or until interlock connection is interrupted
ALL	0 for a particular channel(s)	HI	LED off	LO	LED OFF
	>0 for a particular channel(s)	HI**	LED off	LO	LED turns ON and stays ON until time expires

*** If asserted a second time, before all channels finish their sequence, any channels in which time has expired will re-start, however, any channel that still has time remaining will run for the balance of that remaining time and not restart its timer.*

Example Setup

The following is an example of how to set up the BlueWave QX4 LED Head Controls to operate individually.

1. Set your individual LED Head channels to the desired power level and exposure time. LED Head channels that will use an external PLC control for exposure time should be programmed to zero time.
2. Connect the PLC Sense and GND from the external PLC DC power to the GND connection of the *BlueWave QX4* input. This will put the Controller into PLC control mode.
3. Connect the + voltage from the PLC (through the dropping resistor) to the applicable channel input connection.

NOTE: Separate dropping resistors should be used from voltage to each channel input.

Figure 33.
Connection Diagram

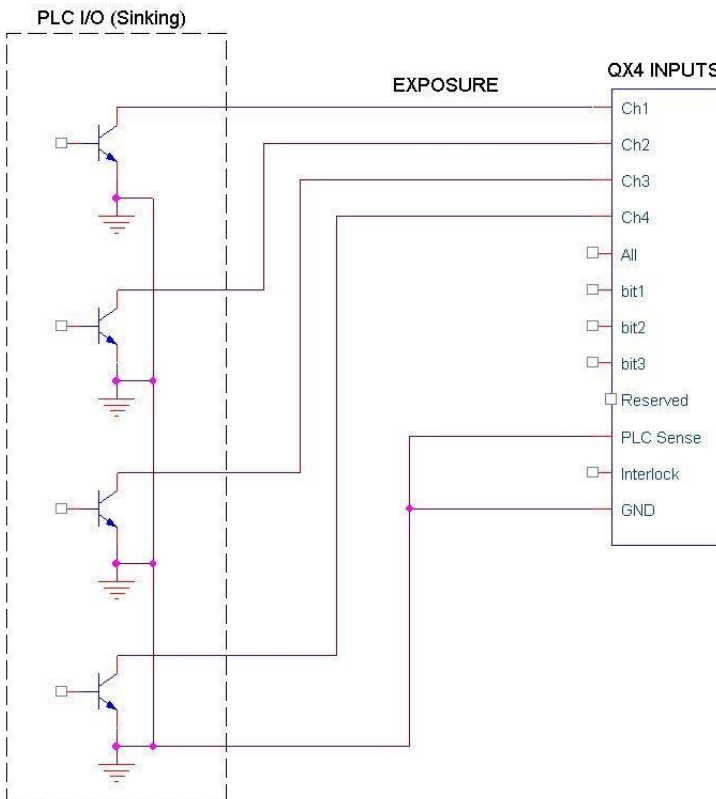

4. To activate a channel, momentarily connect the channel input to the GND for 10 ms or more. The sink current required is approximately 10 mA.
5. Channels that have a preset time will timeout and then stop. Individual channels that have time set to zero, will only activate if the connection to the GND is applied. The channels that have time set to zero will not activate when using the ALL pin. Throughout any exposure cycles, all channels will remain independent of each other so they can be activated in any sequence or order.

System Settings

System settings allow the user to change the language, sounds, and temperature warnings. To enter this menu, navigate using the up/down buttons, then press right button to enter.

Figure 34.
Select System Settings

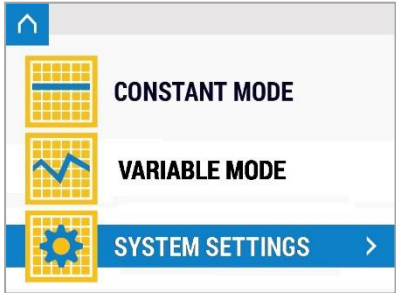

Setting the Language

To set the language, navigate to the first row, then press the right button to edit. Select the language from the list of available languages, then press the center button to set.

Figure 35.
Settings Adjustment Screen

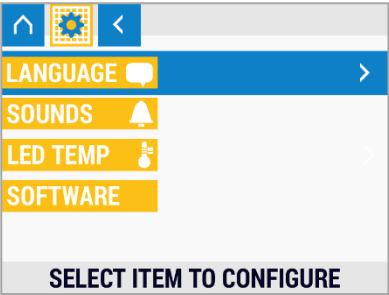
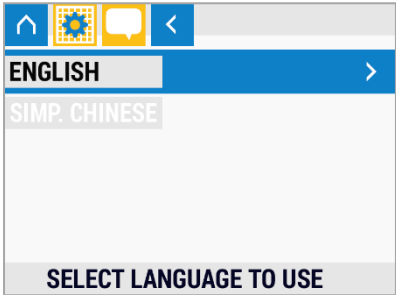

Figure 36.
Language Options Screen



Sound Settings

To modify the sounds configuration, navigate to the second row on the settings adjustment screen, then press right button to enter.

The user can modify the beep volume (sound made on button presses) and alarm volume (sound made when an error occurs). To edit these values, press the right button, then use the up/down buttons to adjust the value. Press the center button to set.

To modify the heads warning temperature, navigate to the bottom row using the up/down buttons. Press center button to edit.

Figure 37.
Setting Adjustment Screen

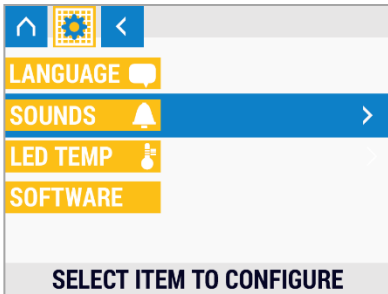
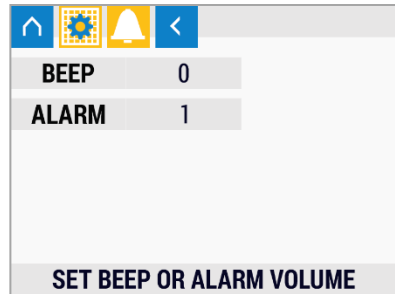

Figure 38.
Sound Options Screen



Temperature Warning Settings

This is a user-defined temperature warning. The temperature-warning setting determines when the orange indicator light will come on. The head will continue to operate normally during the warning. The LED Head will automatically shut off if it reaches an internal critical temperature point of 90°C. Select the head from the list using up/down buttons. Press run button to edit.

Adjust the temperature in Celsius using the up/down buttons. Press center button to set.

Figure 39.
Setting Adjustment Screen

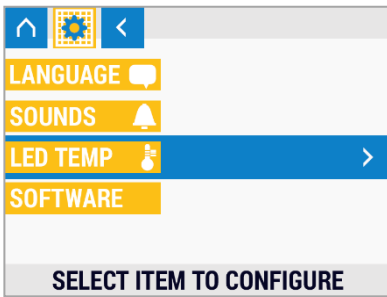
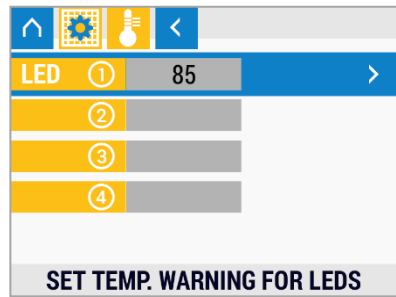

Figure 40.
Temperature Warning Adjustment Screen



Intensity Control Feature

The components used in all light-curing systems degrade with use. Therefore, the maximum intensity decreases as exposure hours accumulate. Setting process intensity requirements lower than the maximum enables the *BlueWave QX4*'s intensity control feature to allow for compensation of gradual decreases in light intensity.

The unit's intensity can be adjusted using the front control panel. The intensity adjustment is software controlled and allows for control of output intensity. See the *Setup Section* for further details on adjusting the Intensity.

Use a radiometer to correlate the percent power output to a reading in W/cm^2 . The adjustment of power level and correlation to a light-intensity value (W/cm^2) enables precise control of light intensity during validation and operation.

Cleaning & Maintenance

LED Head Optic Lens

Based on the cleanliness of your operating environment, establish a schedule for cleaning the LED-head lenses. When cleaning is required, shut the unit down and allow it to cool. When cool, clean the surfaces of the lenses with a clean, lint-free cloth.

Error Codes & Troubleshooting

Error Codes

There is an over-temperature warning signal that flashes in the upper right-hand corner of the screen when an LED head has reached the user-defined warning limit. The front indicator will turn orange to indicate which head has reached the set temperature, but the LED head will still be operational.

There is an over-temperature critical warning signal that will shut down the unit when the critical temperature limit has been reached. A critical error message will display on the screen and remain until the head has cooled to a safe operating temperature. The operator must then clear the warning screen before operation can resume.

Figure 41.
Cool-Down Screen

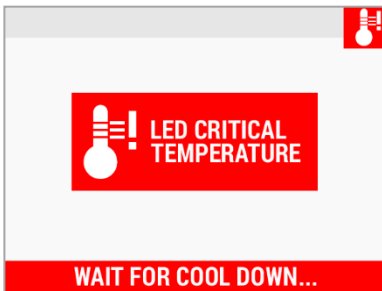

Figure 42.
Temperature Recovered Screen



Table 2.
 Troubleshooting Chart for BlueWave QX4

Problem	Possible Cause	Corrective Action
BlueWave QX4 does not power up	Power cord not plugged in or damaged	Check power connection and condition at power supply “Brick” and controller.
	No electrical power at Receptacle	Test Receptacle for power.
BlueWave QX4 powers up but the LED head does not produce light	LED intensity adjustment set to 0%	Increase LED intensity setting.
	LED cycle time is set to 0 seconds	Increase cycle time setting.
	Interface cable connections loose or damaged	Check connections and condition of Interface Cable.
	In variable mode, the cycle count is set to 0	Adjust the cycle count to the desired number.
	LED head is not connected to the correct port/channel	Verify that the head is connected to the desired port/channel.
BlueWave QX4 is operating normally, and the head suddenly stops producing light	Over-temperature shutdown was triggered	Check if the front panel over-temperature indicator is red. If so, allow the head to cool and follow the instructions on the screen.
LED head provides only low-intensity light	LED intensity adjustment set to minimum	Increase LED intensity setting.
	Contaminated/dirty lens optics	Clean the surface of the Lens.
Footswitch does not function	Footswitch not connected	Connect footswitch.
	Footswitch defective	Activate unit using the front control panel. Replace the footswitch if the unit operates from the front control panel.

Spare Parts and Accessories

Item	Part Number
Personal Protection Equipment	
Protective Goggles — Green	35286
Protective Goggles — Gray (standard model included w/unit)	35285
Face Shield	35186
Radiometer	
Dymax ACCU-CAL™ 50-LED Radiometer (spot)	40505
LED Heads, 1.0 meter	
VisiCure	43161
PrimeCure	43162
RediCure	43163
Lens, Focusing	
ø3 mm, Spot	43164
ø5 mm, Spot	43165
ø8 mm, Spot	43166
Extension Cables	
Connection Cable, 0.5 M Extension	41563
Connection Cable, 1.0 M Extension	41564
Connection Cable, 1.5 M Extension	41565
Connection Cable, 2.0 M Extension	41566
Power Cords	
Power Cord, North America	41548
Power Cord, China	41549
Key System Components	
AC Power Adapter	41547
Controller Only (North American Version - Cord w/120V Plug)	41571
Footswitch (Optional)	5028

Specifications



Property	Specification		
LED Head	RediCure	PrimeCure	VisiCure
Intensity Output*	13.9W/cm ²	18.8 W/cm ²	14.9 W/cm ²
Output Frequency	365 nm	385 nm	405 nm
Power Supply Input	100-240 V ~ 2 A, 50/60 Hz		
LED Timer	0.1 to 999 seconds		
LED Activation	Footswitch, front panel, or PLC		
Cooling	Natural convection		
Controller Dimensions, W x D x H	3.5" x 5.5" x 5.6" [9.0 cm x 14.1 cm x 13.7 cm]		
LED Head Dimensions	See Figure 44		
Weight	Controller: 2.3 lbs. [1.03 kg] / Head: 0.2 lbs. [0.08 kg]		
Unit Warranty	1 year from purchase date		
Operating Environment	5 - 40°C [41-104°F], non-condensing		
Recommended Accessories	40505 ACCU-CAL™ 50-LED Radiometer		

*Measured with 3-mm lens using Dymax ACCU-CAL™ 50-LED Radiometer, in spot mode at a distance of 5 mm.

Figure 43.
BlueWave QX4 Spectral Output

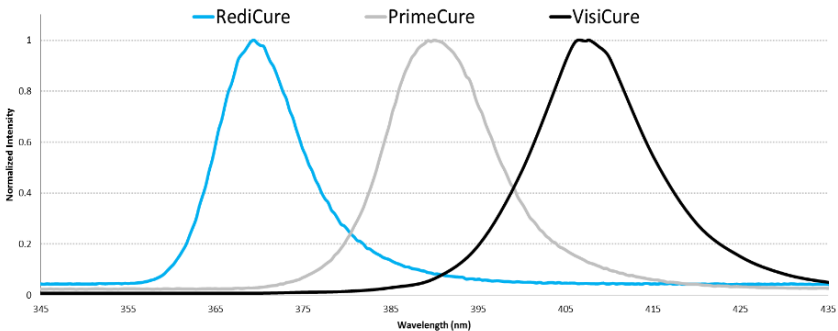

Figure 44.
Dimensions - LED Heads

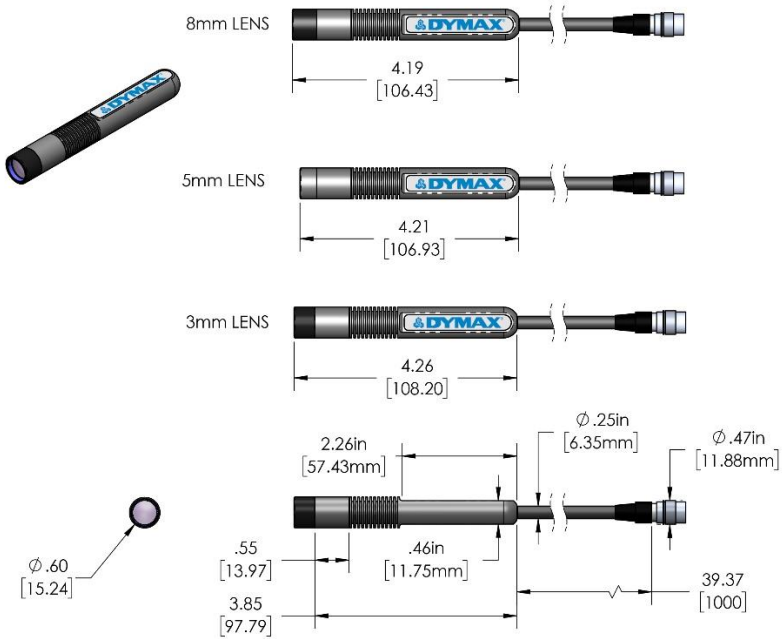
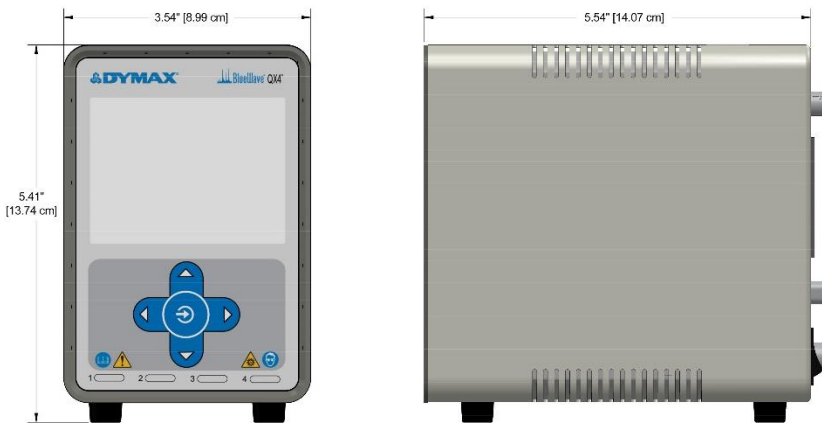

Figure 45.
Dimensions - Controller



Declaration of Conformity



Declaration of Conformity

Manufacturer:
DYMEX Corporation
318 Industrial Lane
Torrington, CT 06790, USA

European Address:
DYMEX Europe GmbH
Kasteler Str.45
Geb.G359
Wiesbaden Germany 65203

UK Address:
Dymax
1b Hunts Grove Drive, Hardwick,
Gloucester, Gloucestershire, GL2 4BH
United Kingdom

Product description:
Model name(s):
UV Curing Device
BlueWave® QX4™

This product complies with the following Directives, legal acts and standards:

European Union Compliance (CE)

Electromagnetic Compatibility Directive (2014/30/EU):
EN 61000-6-3:2007+A1:2011+AC:2012
EN 61000-3-2:2014
EN 61000-3-3:2013
EN 61000-6-1:2007
IEC 61000-4-2:2009
IEC 61000-4-3:2006 + A1:2008 +A2:2010
IEC 61000-4-4:2012
IEC 61000-4-5:2014+A1:2017
IEC 61000-4-6:2014 + AC:2015
IEC 61000-4-8:2010
IEC 61000-4-11:2004+A1:2017

Low Voltage Directive (2014/35/Eu):
EN 61010-1:2010 (3rd Edition)
IEC 61010-1:2010 (3rd Edition)
IEC 62471 (2006)

RoHS Directive (2015/863):

Declaration:

I declare that the above information in relation to the supply and manufacture of this product is in conformity with the above standards and directives.



3-10-2021

Name

Date

Authorized Signatory:
Richard MacCutcheon
Engineering Manager
DYMEX Corporation
Torrington, CT., USA

Representative in Europe:
Dominik Stephan
Director, Equipment
DYMEX EUROPE GmbH
Wiesbaden, Germany

Representative in UK:
Kevin Westcott
Account Manager
DYMEX
Gloucester, United Kingdom

www.dymex.com

Americas
USA | +1.800.482.1010 | info@dymex.com

Europe
Germany | +49 611 992 7000 | info_de@dymex.com
Ireland | +353 21 237 3018 | info_ie@dymex.com

Asia
Singapore | +65 67522887 | info_ap@dymex.com
Shanghai | +86 21 38765758 | info_cn@dymex.com
Shenzhen | +86 755 34463751 | info_cn2@dymex.com
Hong Kong | +852 2490 7038 | dymexasia@dymex.com
Korea | +82 31 838 3434 | info_kr@dymex.com

©2020 Dymex Corporation. All rights reserved. All trademarks in this guide, except where noted, are the property of, or used under license by, Dymex Corporation, U.S.A.

Warranty

From date of purchase, Dymax Corporation offers a one-year warranty against defects in material and workmanship on all system components with proof of purchase and purchase date. Unauthorized repair, modification, or improper use of equipment may void your warranty benefits. The use of aftermarket replacement parts not supplied or approved by Dymax Corporation, will void any effective warranties and may result in damage to the equipment.

IMPORTANT NOTE: DYMAX CORPORATION RESERVES THE RIGHT TO INVALIDATE ANY WARRANTIES, EXPRESSED OR IMPLIED, DUE TO ANY REPAIRS PERFORMED OR ATTEMPTED ON DYMAX EQUIPMENT WITHOUT WRITTEN AUTHORIZATION FROM DYMAX. THOSE CORRECTIVE ACTIONS LISTED ABOVE ARE LIMITED TO THIS AUTHORIZATION.

Index

- 4-Channel Mode, 29
 - Controller Set Up, 29
 - I/O Connection, 29
- Back Panel Controls, 12
- Cleaning the Lens, 35
- Components*, 8
- Connections, 13
- Constant Mode, 16
 - Irradiation, 18
 - Set Up, 17
- Curing System Safety, 6
 - Description*, 8
- Error Codes, 36
- Features and Benefits, 9
- Focusing Lenses, 14
- Front Panel Controls, 10
- Help, 4
- Intensity Control Feature, 35
- LED Heads, 14
- Lens Cleaning, 35
- Operation, 16
- Optional Equipment, 38
- Parts Included, 13
- Parts List, 13
- PLC*, 22
- Product Overview, 8
- Safety, 4
- Safety of UV Light
 - Bright Visible Light, 8
 - High-Temperature Surfaces, 7
 - UV Exposure, 6
- Settings, 33
 - Language, 33
 - Sound, 33
- Setup, 13
- Spare Parts and Accessories, 38
- Specifications, 39
- Support, 4
- Temperature Warning Setting, 34
- Troubleshooting, 37
- Unpacking, 13
- UV Exposure, 6
- UV Light Shielding, 7
- Validation, 9
- Variable Mode, 19
 - Irradiation, 21
 - Set Up, 19
- Warranty, 41

www.dymax.com

Americas

USA | +1.860.482.1010 | info@dymax.com

Europe

Germany | +49 611.962.7900 | info_de@dymax.com
Ireland | +353 21.237.3016 | info_ie@dymax.com

Asia

Singapore | +65.67522887 | info_ap@dymax.com
Shanghai | +86.21.37285759 | dymaxasia@dymax.com
Shenzhen | +86.755.83485759 | dymaxasia@dymax.com
Hong Kong | +852.2460.7038 | dymaxasia@dymax.com
Korea | +82.31.608.3434 | info_kr@dymax.com

© 2021 Dymax Corporation. All rights reserved. All trademarks in this guide, except where noted, are the property of, or used under license by Dymax Corporation, U.S.A.

Please note that most curing system applications are unique. Dymax does not warrant the fitness of the product for the intended application. Any warranty applicable to the product, its application and use is strictly limited to that contained in Dymax standard Conditions of Sale published on our website. Dymax recommends that any intended application be evaluated and tested by the user to ensure that desired performance criteria are satisfied. Dymax is willing to assist users in their performance testing and evaluation by offering equipment trial rental and leasing programs to assist in such testing and evaluations.

MAN075 4/20/2021