

Duet 2 Wifi motion controller wiring setup for MK3s

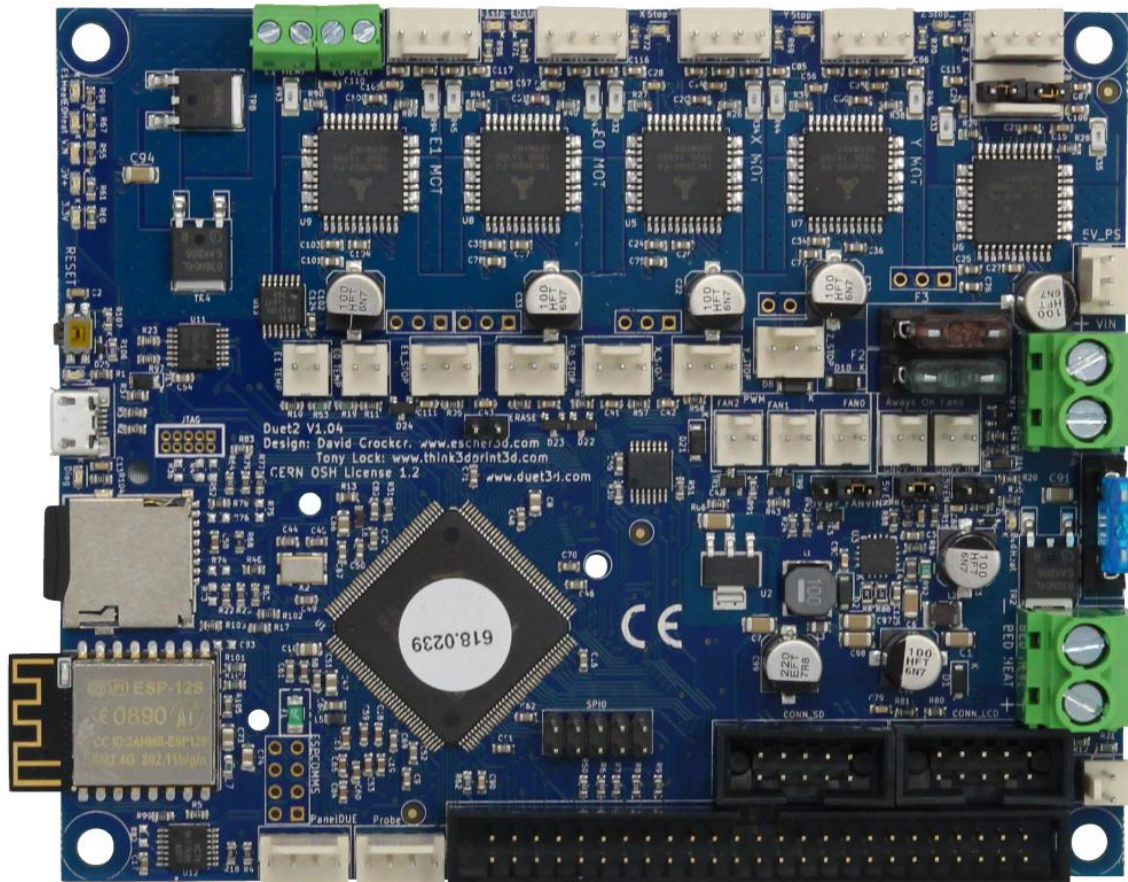

WARNINGS AND PRECAUTIONS

READ ALL THE MANUFACTURER'S APPLICABLE DOCUMENTATION!

- It is your responsibility to read, understand, and adhere to the applicable documentation for this controller board and any other devices that are to be attached to it.
- Lack of adherence / compliance to the equipment manufacturer's documentation and warnings can result in equipment, personnel, and property damage.
- Any / all authors of this documentation bear no responsibilities to your equipment or any damages that may occur.

!! Before proceeding further with the wiring, you should have already completed the duet3d guide, Step 1, located here:

[https://duet3d.dozuki.com/Guide/1.\)+Getting+Connected+to+your+Duet/7?lang=en](https://duet3d.dozuki.com/Guide/1.)+Getting+Connected+to+your+Duet/7?lang=en)

!! After completion of Step 1, you should have completed the wifi configuration and software update to the duet board. Proceed to <https://github.com/rkolbi/RRF-machine-config-files/tree/master/Prusa%20MK3s>, review the readme and then copy the config files from the repository to the duet sd-card. Huge thanks to Ben Argolein and Duet3d forums!

!! Before wiring up the MK3s, please proceed to the duet3d guide, Step 2, just to familiarize yourself with the overall wiring diagram, cautions, and warnings.

[https://duet3d.dozuki.com/Guide/2.\)+Wiring+your+Duet+2+WiFi-Ethernet/9?lang=en](https://duet3d.dozuki.com/Guide/2.)+Wiring+your+Duet+2+WiFi-Ethernet/9?lang=en)

!! Never blindly trust stepper motors' wiring colors, always check phases. Mixing the phases up on the 4-pin connector can and often does result in damage to the stepper driver. Be especially careful when using stepper motors with detachable cables! https://duet3d.dozuki.com/Wiki/Choosing_and_connecting_stepper_motors

?? When in need of assistance, the Duet3d forums are a great place to search and ask questions. <https://forum.duet3d.com/>

WIRING OVERVIEW

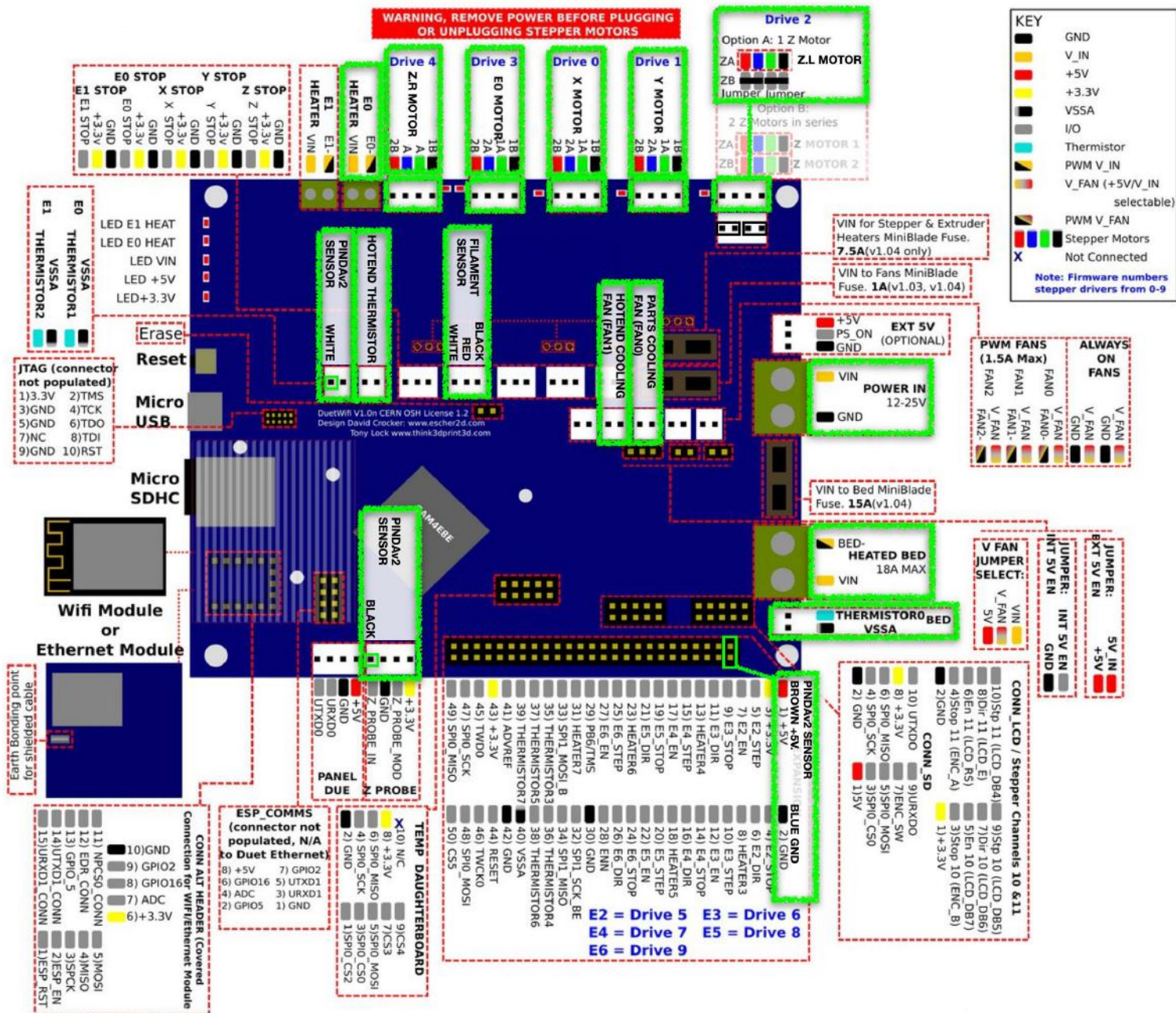

Upon completion of the guide, you will have made all the above connections denoted by GREEN highlight.

STEPPER MOTOR (independent Z-axis control)

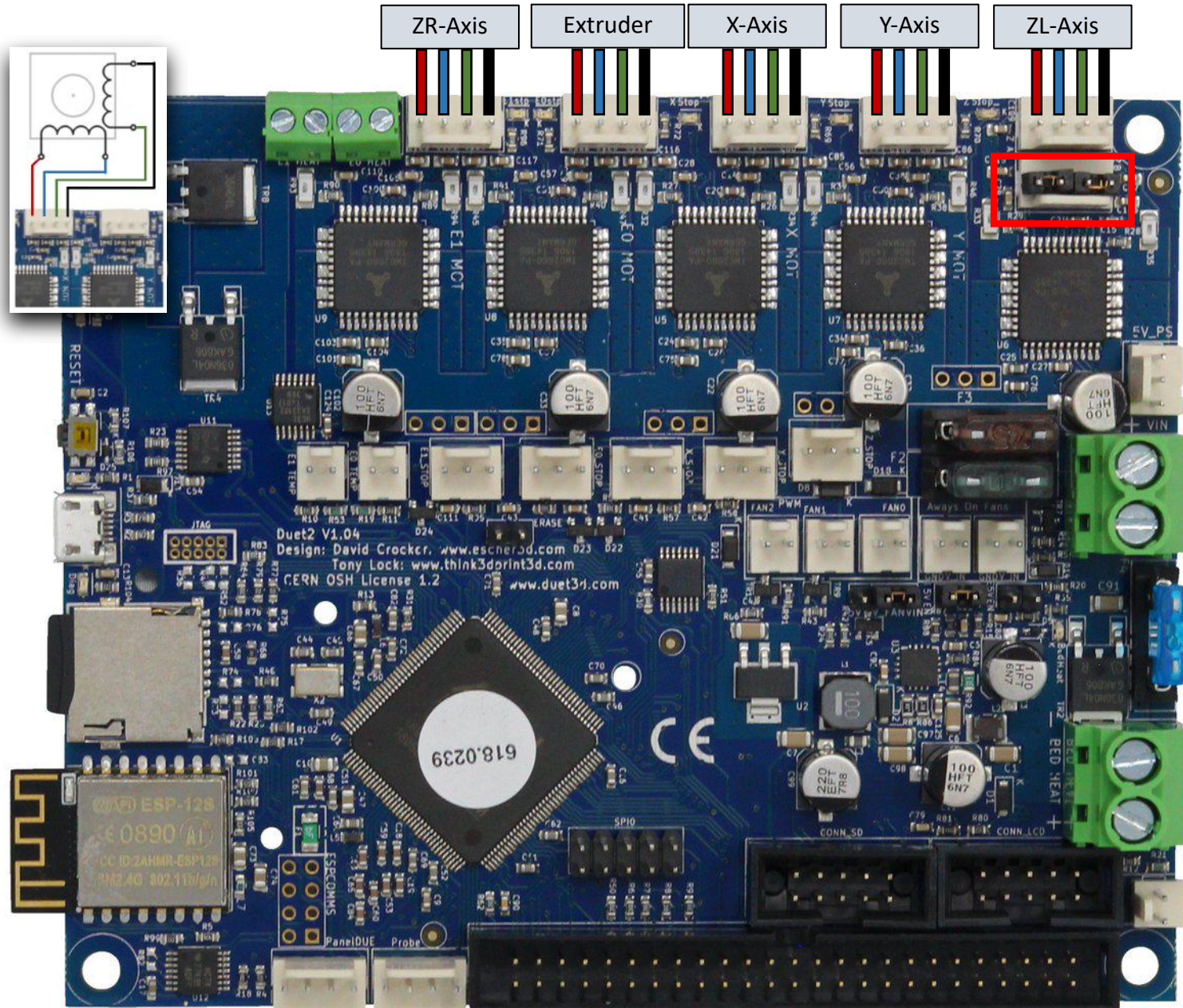

*Be sure that the supplied jumpers are installed on the ZB connector. Coil 2: Red(-) Blue(+) / Coil 1: Green(+) Black(-)

PINDA v2 (with thermistor)

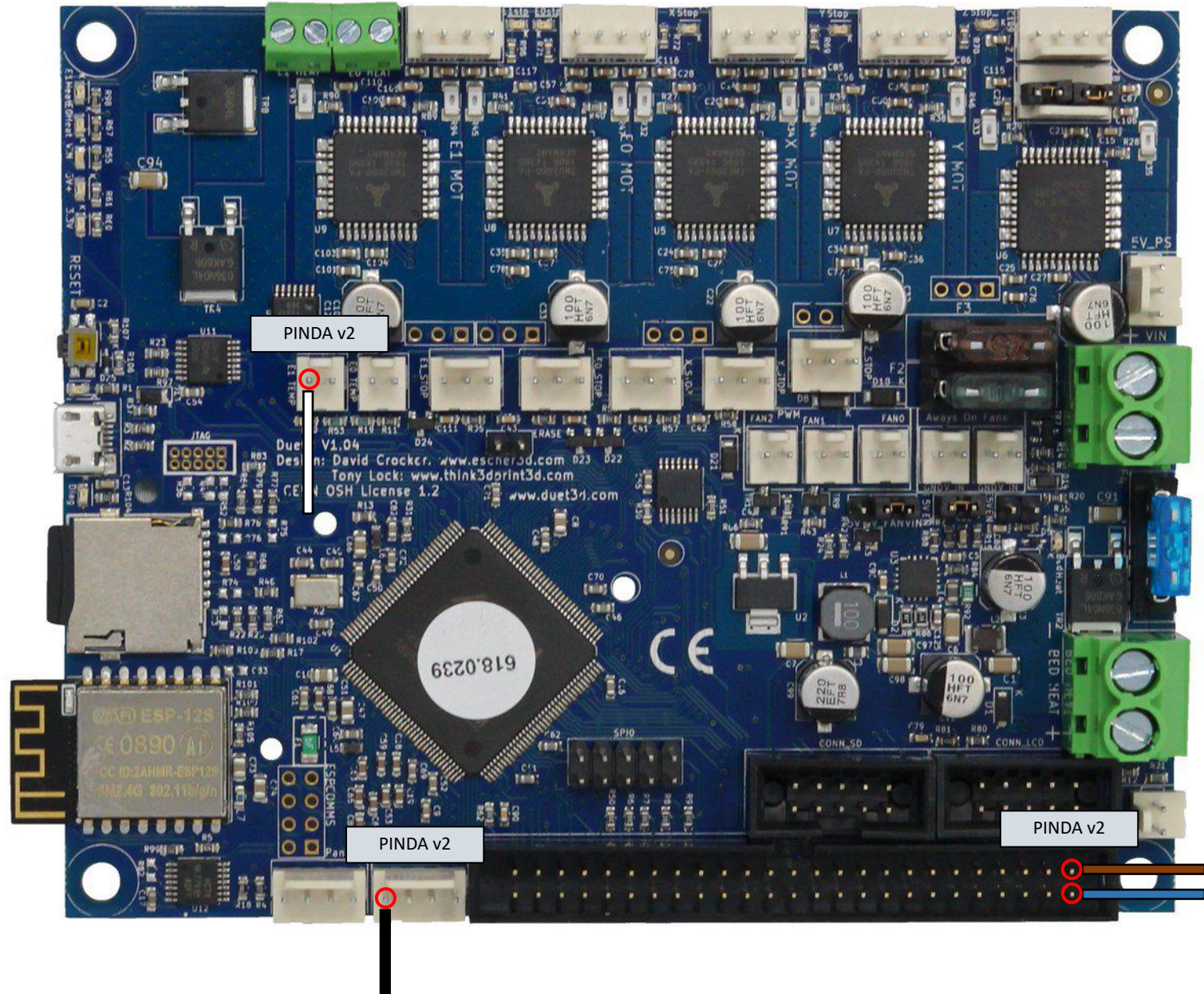

*The PINDA v2 probe needs to be split into three connections; WHITE for temperature sense, BLACK for probe trigger, and power as BROWN +5v & BLUE GND.

FILAMENT SENSOR

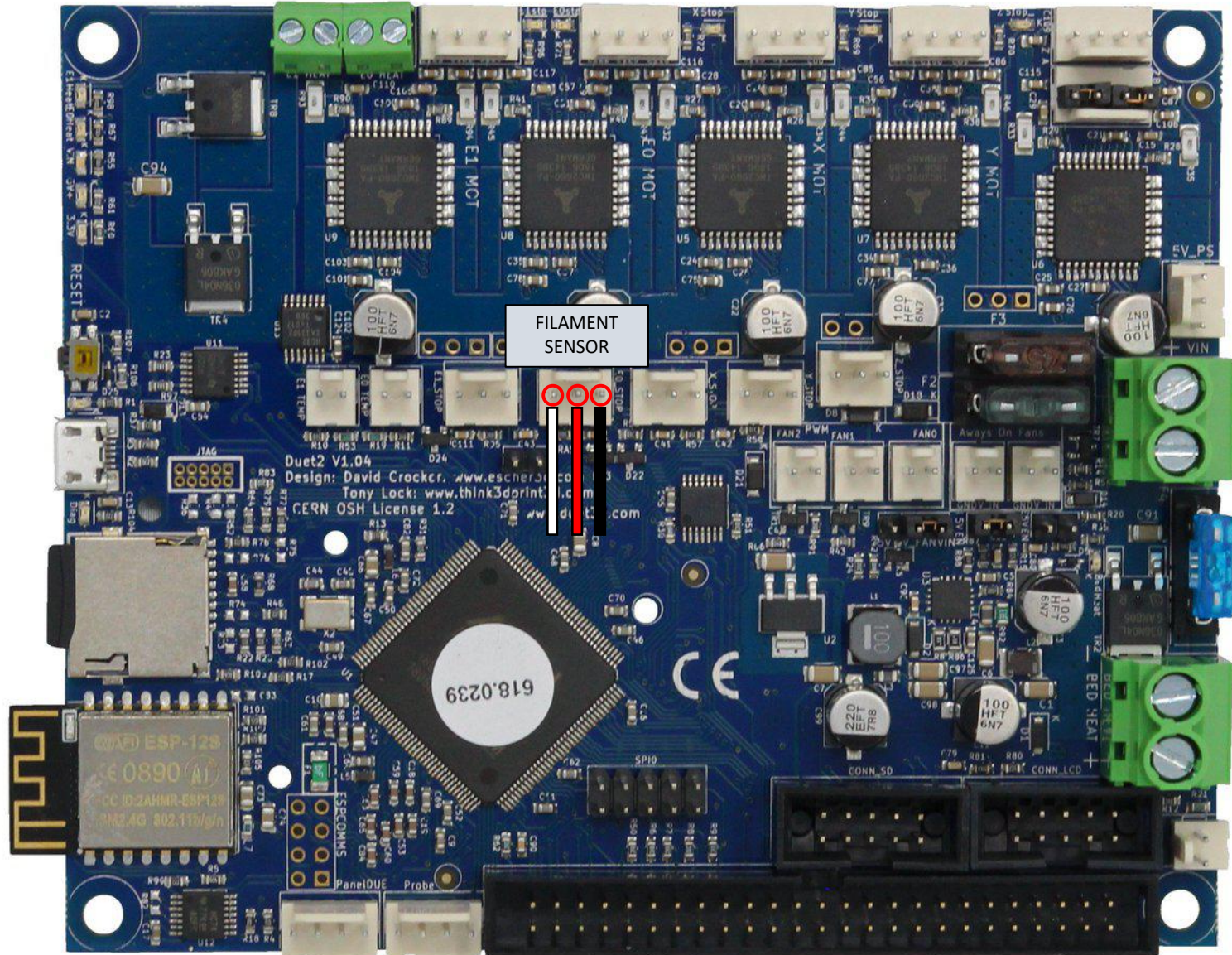

HOTEND FAN, PART COOLING FAN, AND CASE FAN

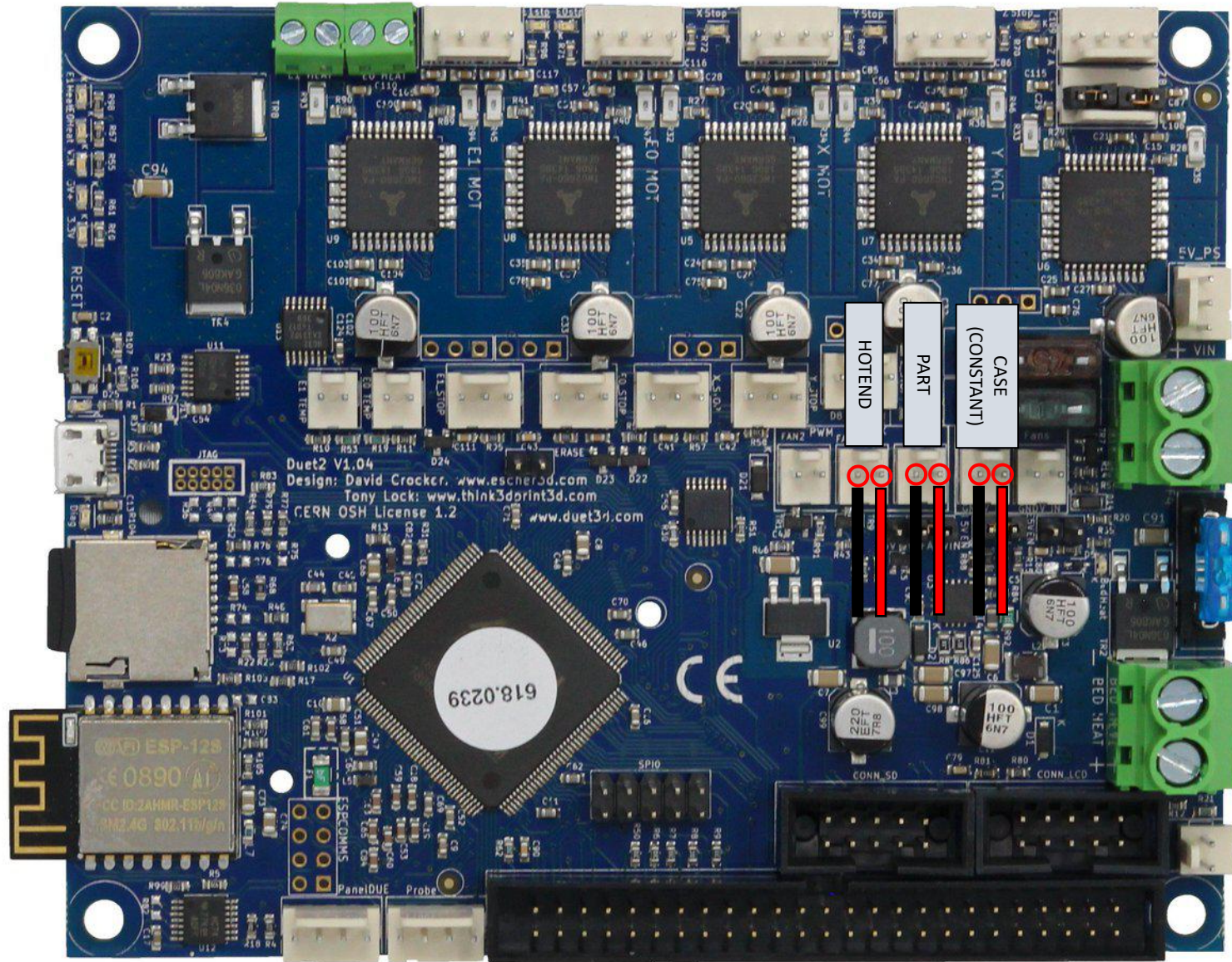

*The case fan is optional. As shown, the two rightmost connections are constant supplied - always on. The far left (FAN2) connection is available and can be programmed to operate at a defined condition, such as when the MCU or hotend reach a certain temperature. This is beyond the scope of this guide, but information is available in the forums.

CASE FAN AUTO CONTROL

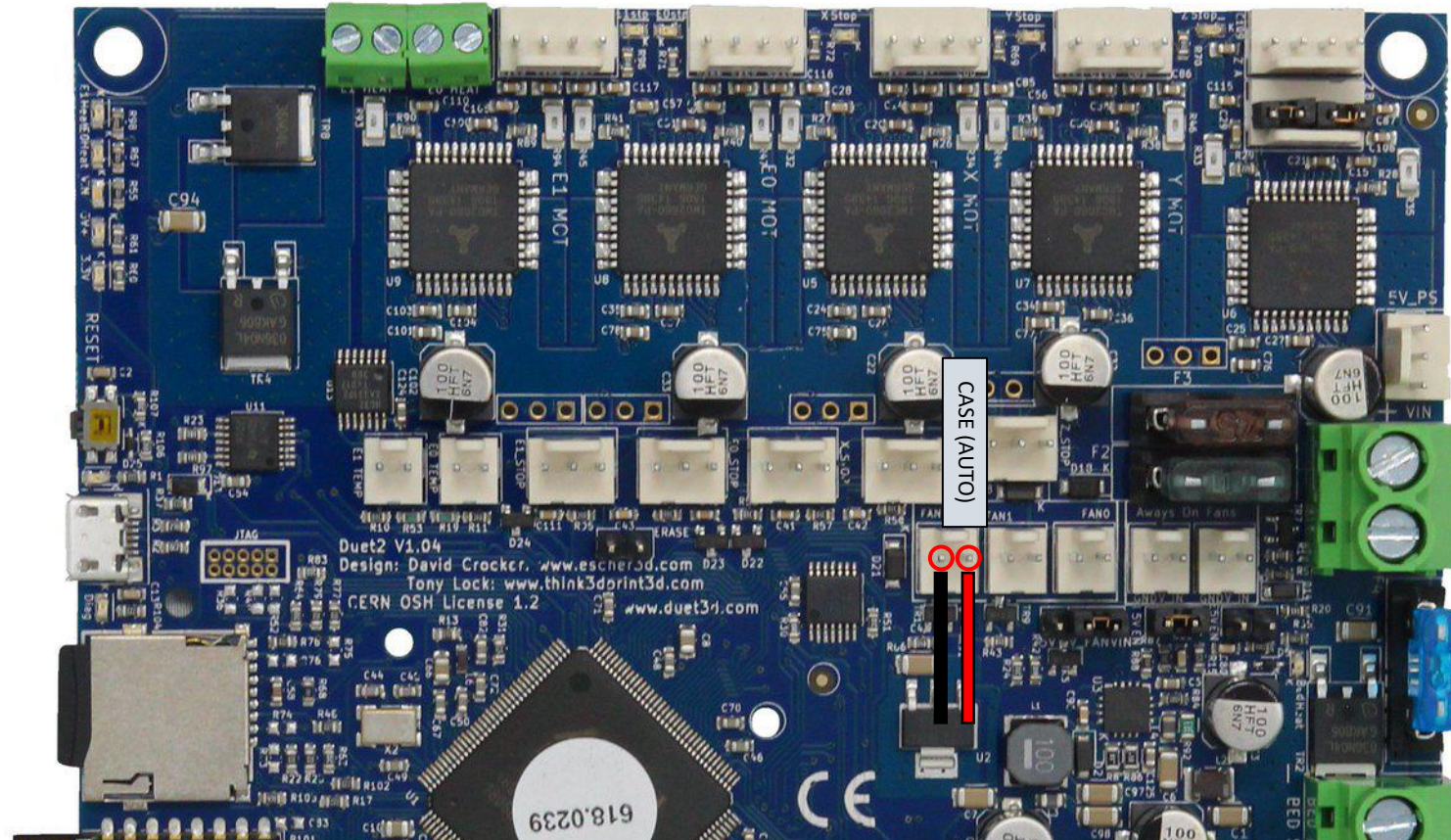

```
76 ; Fans
77
78 M950 F1 C"Fan1" Q250 ; Creates HOTEND Fan
79 M106 P1 T45 S255 H1 ; HOTEND Fan Settings
80 M950 F0 C"Fan0" Q250 ; Creates PARTS COOLING FAN
81 M106 P0 H-1 ; Set fan 1 value, PWM signal inversion and frequency. Thermostatic control is turned off PARTS COOLING FAN
82 ; The following lines are for auto case fan control, attached to 'fan2' header on duet board
83 M308 S2 Y"drivers" A"DRIVERS" ; Case fan - configure sensor 2 as temperature warning and overheat flags on the TMC2660 on Duet
84 M308 S3 Y"mcu-temp" A"MCU" ; Case fan - configure sensor 3 as thermistor on pin eltemp for left stepper
85 M950 F2 C"fan2" Q100 ; Case fan - create fan 2 on pin fan2 and set its frequency
86 M106 P2 H2:3 L0.15 X1 B0.3 T40:70 ; Case fan - set fan 2 value
87
88
```

*If you desire to use auto case fan control, plug the case fan into the FAN2 port on the duet board and add lines 83 through 86 under the FANS section of your config.g file. Please read the full documentaion here: https://duet3d.dozuki.com/Wiki/Mounting_and_cooling_the_board#Section_Cooling

HOTEND POWER AND THERMISTOR

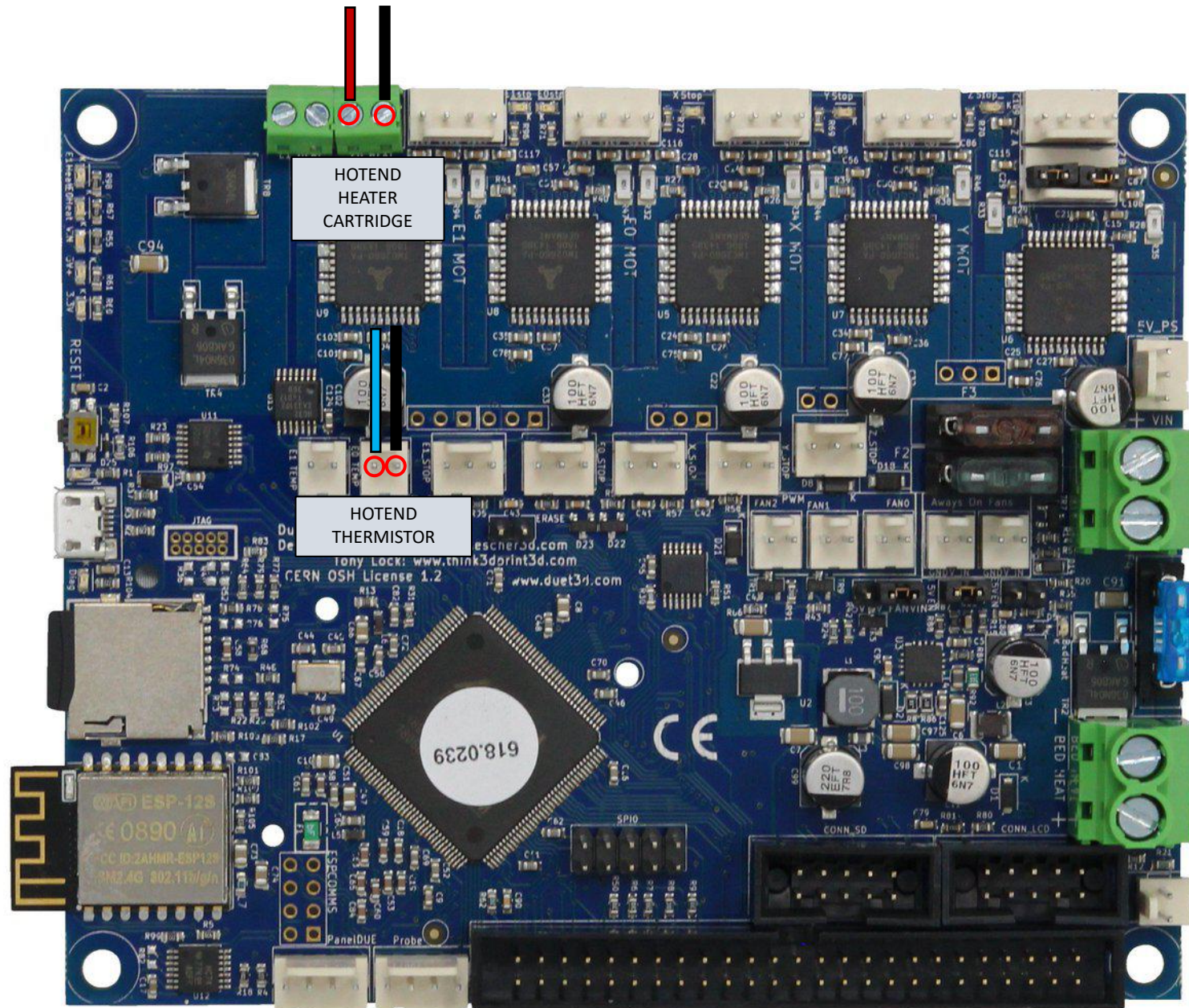

*Polarity does not matter for hotend heaters.

*The polarity of a thermistor does not matter.

BED POWER AND THERMISTOR

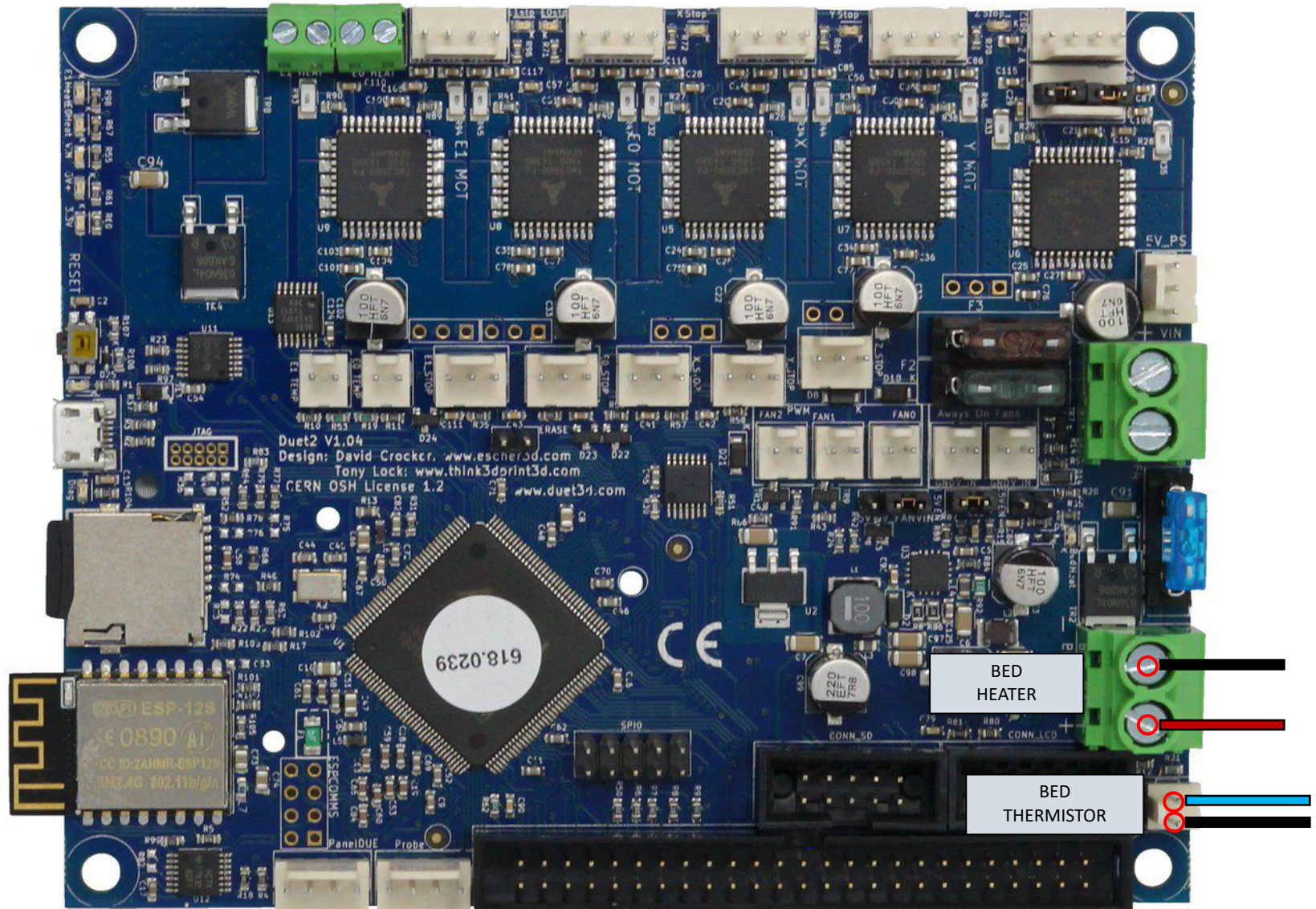

*If your heater has an integrated LED, then the polarity will matter as the LED will not light with reverse polarity. Otherwise, a heater's polarity doesn't matter.

*The polarity of a thermistor does not matter.

POWER IN – 24 VOLT

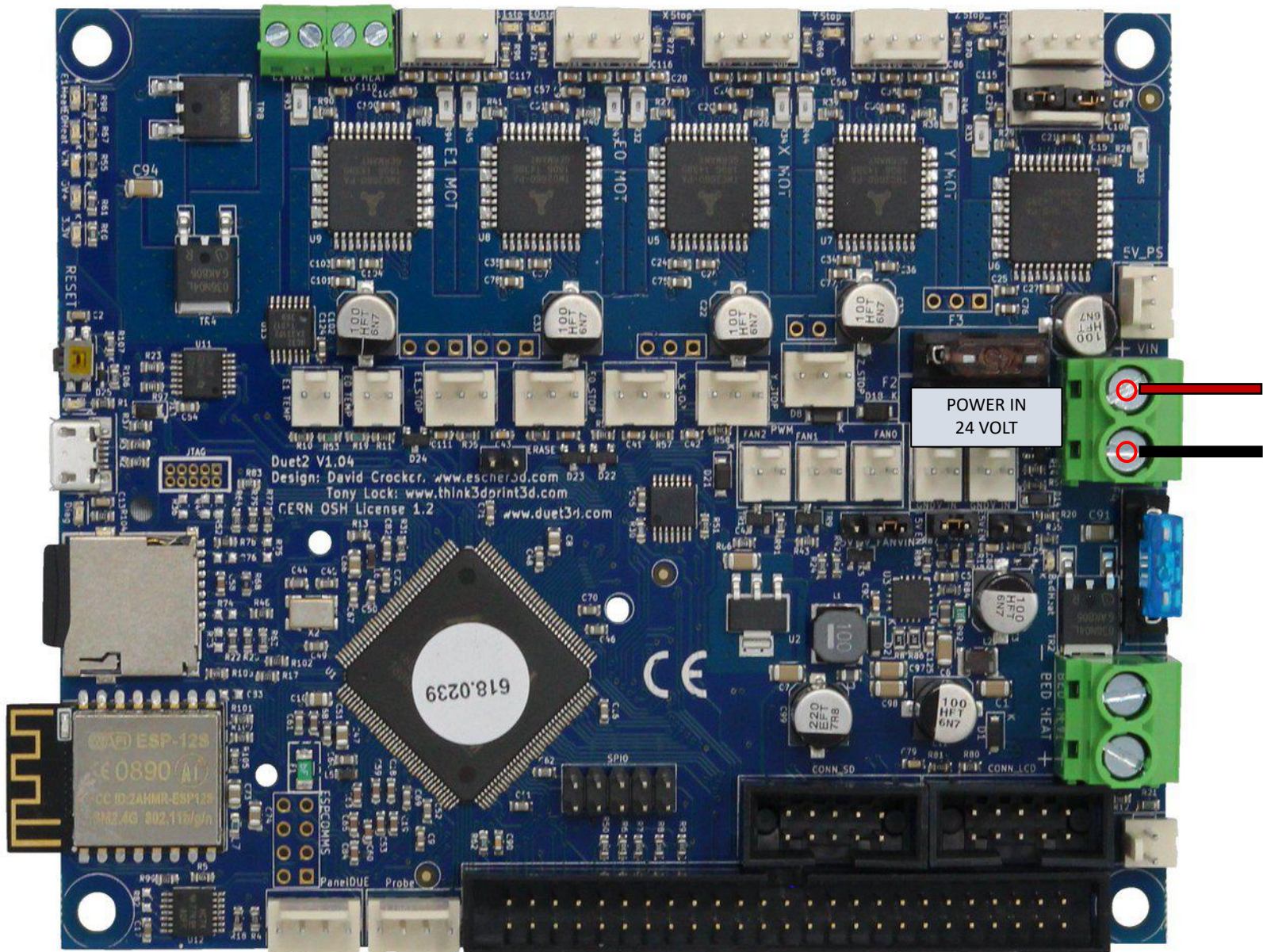

*Unlike the Einsy RAMBo controller board, the Duet controller only requires 1 set of power cables.

You can feed both PSU cables into the single VIN terminal block on the Duet if they will fit, or else run a single heavy-duty cable from the PSU to the Duet.

POWER IN – 24 VOLT EXPECTED LED INDICATIONS

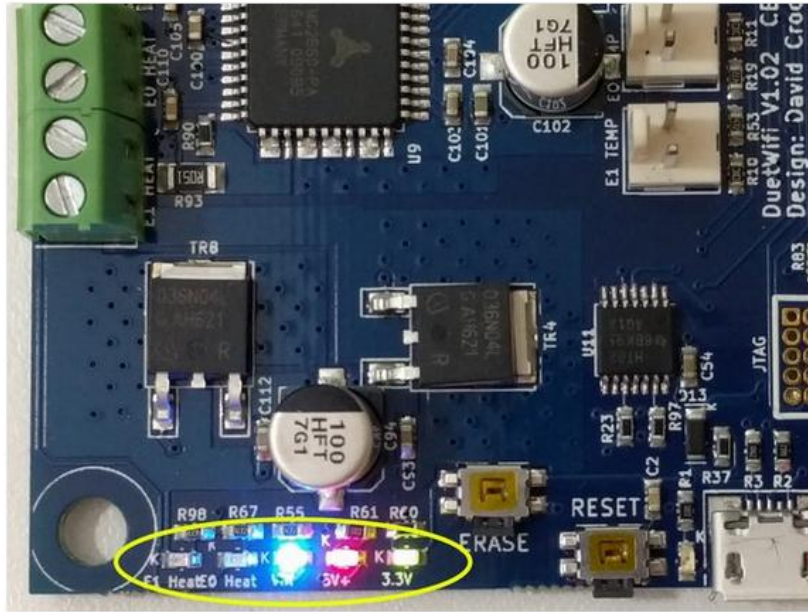

- These indicators show the status of 3.3v power, 5v power, the Vin (power from your power supply) and the two extruder heaters.
- When the board is idle and connected to a power supply, expect the 3.3v, 5v, and Vin LEDs to be illuminated.
- When the board is powered only through an external 5v supply or through USB, expect only the 5v and 3.3v lights to be on.
- In this area you will also find indicators to show when an extruder heater is turned on.



My Duet wifi didn't power up the 5V/3.3V circuit when I connected my 24V PSU. The issue was that the INT 5V_EN jumper to drive the 5V circuit was not placed properly. I assume that this jumper should be connected as default when delivered as it is not mentioned in this guide. However, the jumper on my board was only sitting on one of the pins. Something to look out for if you are having issues here.

PANELDUE CONNECTION

DuetWifi to PanelDue Connection

PanelDue

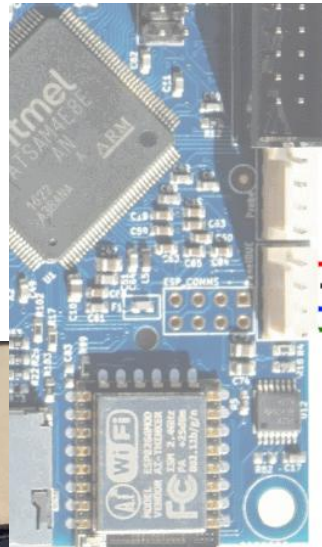

DuetWifi

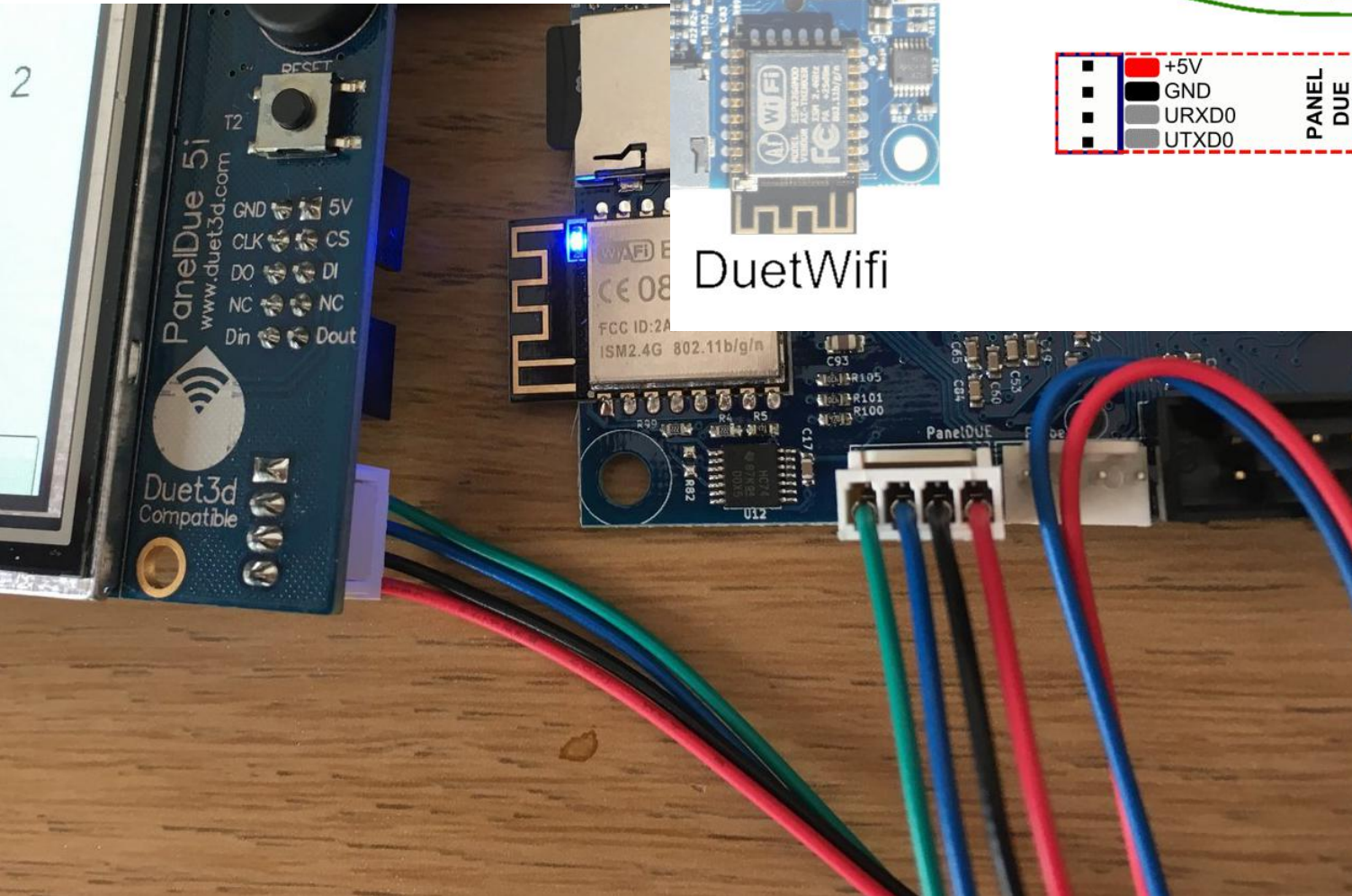
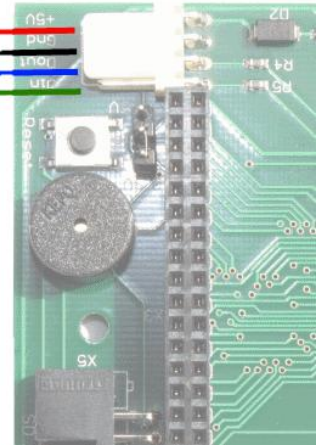

2

DUET 2 WIFI LED INDICATIONS

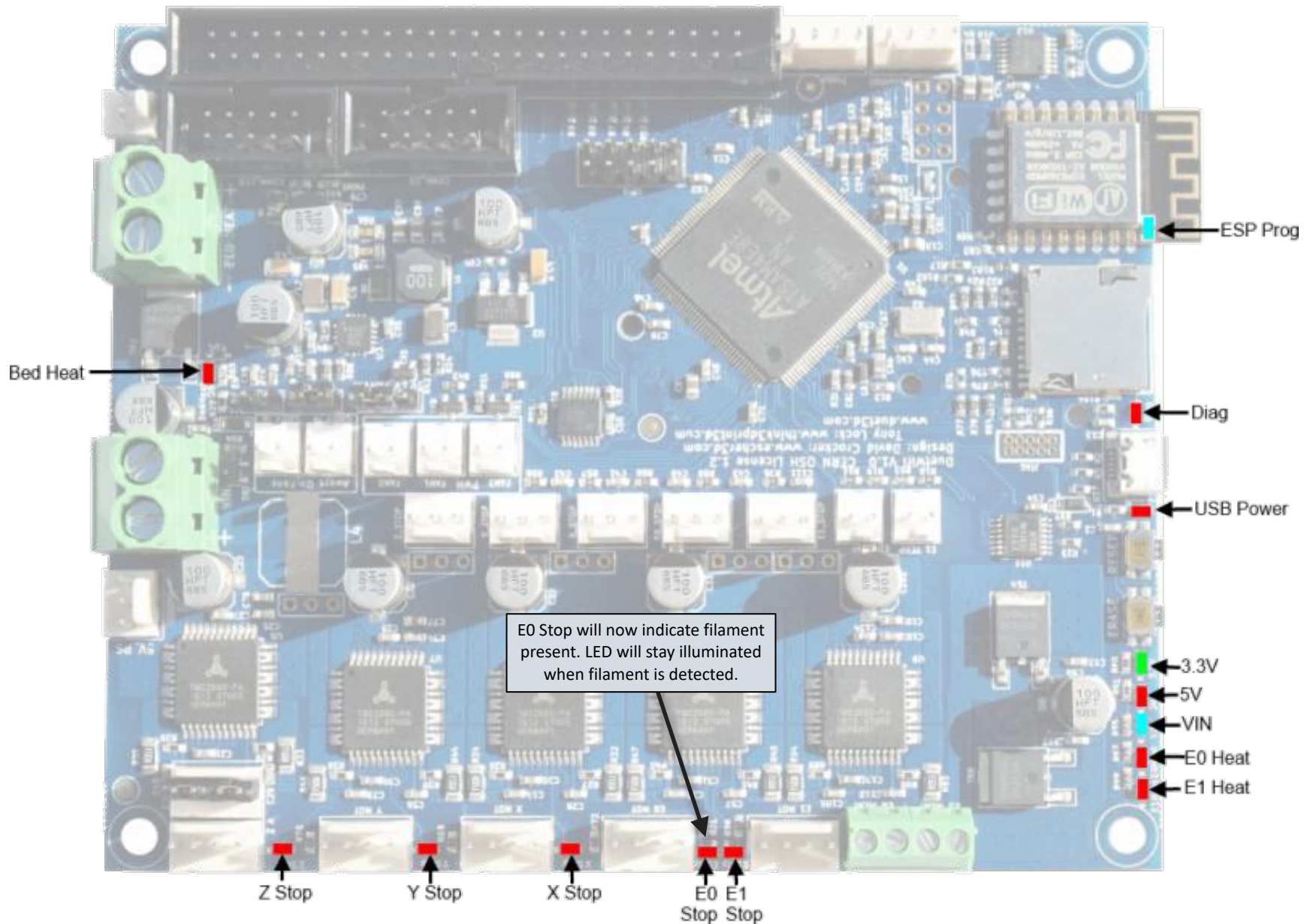

Duet Wifi / Duet Ethernet Connections

v1.0 to v1.04

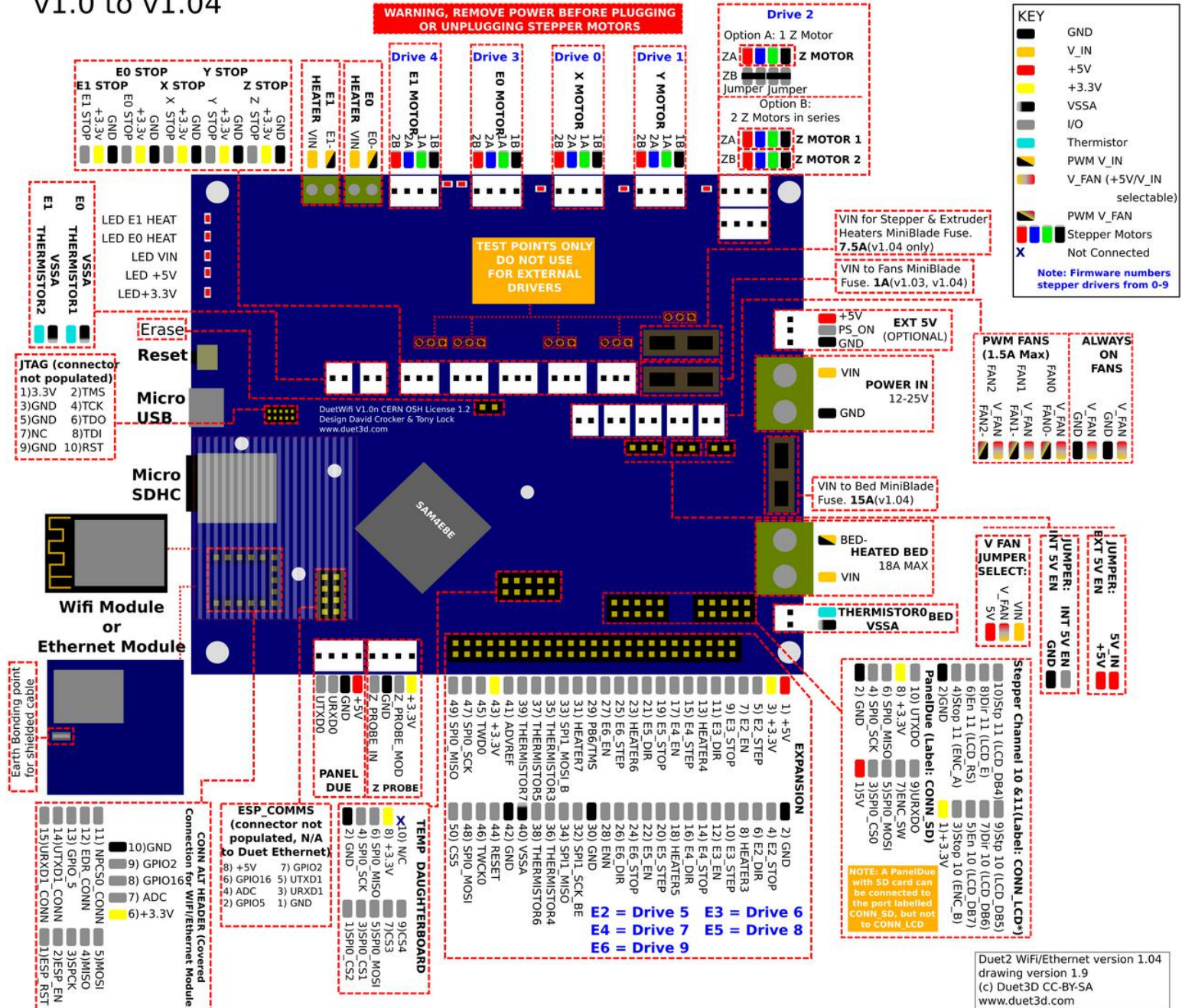

DUET 2 WIFI DIMENSIONS

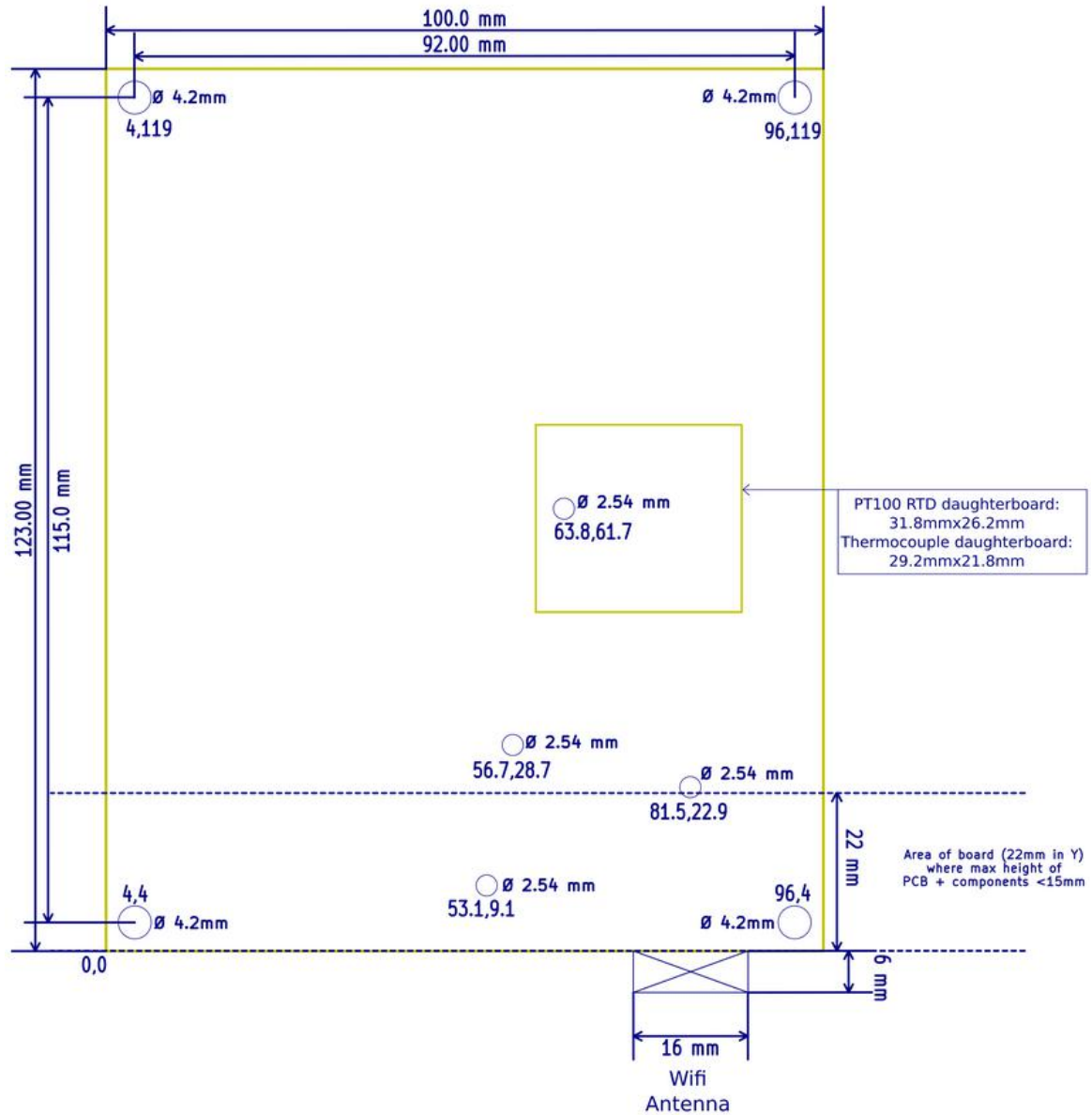

BLTouch v3.1

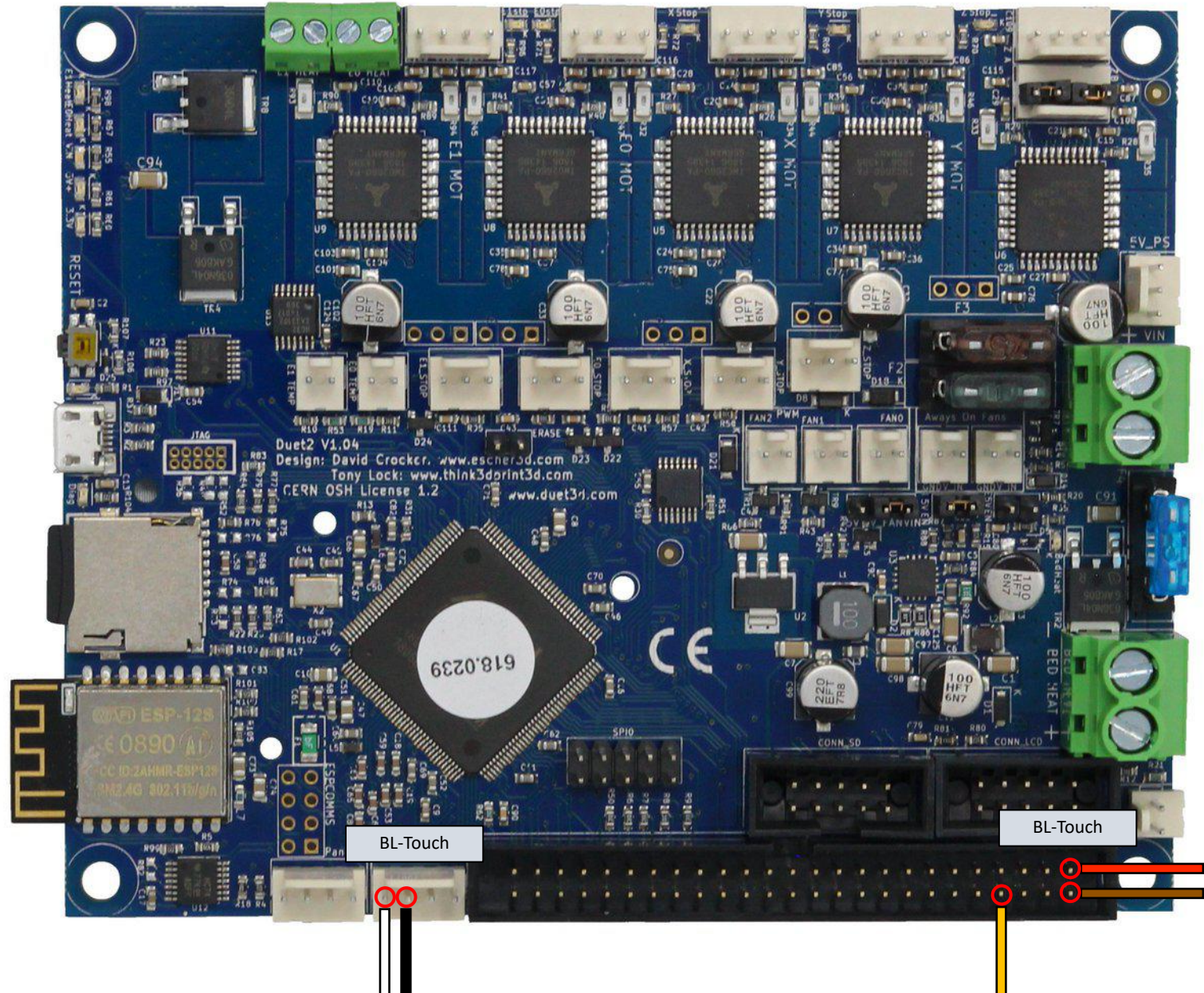

*The BL-Touch probe needs to be split into three connections; WHITE & BLACK for probe trigger, YELLOW as PWM(exp.heater3), and power as RED +5v & BROWN GND.

BLTouch v3.1

- !! Read the Duet3d wiki article on connecting a BLTouch probe. https://duet3d.dozuki.com/Wiki/Connecting_a_Z_probe

```
; Z-Probe Settings
✓;M558 P9 C"^zprobe.in" H5 F200 T3000 ; USE FOR BL_TOUCH! Connected to Z probe IN pin
✓;M950 S0 C"exp.heater3" ; USE FOR BL_TOUCH! Create servo/gpio 0 on heater 3 pin on expansion
M574 Z1 S2 ; Set endstops controlled by probe
✗M558 P5 C"^zprobe.in" I1 H0.7 F400 T8000 A20 S0.003 ; USE FOR PINDA!
✗M308 S2 P"e1_temp" A"Pinda V2" Y"thermistor" T100000 B3950 ; USE FOR PINDA!
M557 X25:235 Y10:195 P9 ; Define mesh grid for probing
```

In the /sys/config.g file, comment out the ✗M558 & ✗M308 lines for the Pinda, uncomment to ✓M558 & ✓M590 for the BLTouch.

Your config.g should look like the example below.

```
; Z-Probe Settings
M558 P9 C"^zprobe.in" H5 F200 T3000 ; USE FOR BL_TOUCH! Connected to Z probe IN pin
M950 S0 C"exp.heater3" ; USE FOR BL_TOUCH! Create servo/gpio 0 on heater 3 pin on expansion
M574 Z1 S2 ; Set endstops controlled by probe
;M558 P5 C"^zprobe.in" I1 H0.7 F400 T8000 A20 S0.003 ; USE FOR PINDA!
;M308 S2 P"e1_temp" A"Pinda V2" Y"thermistor" T100000 B3950 ; USE FOR PINDA!
M557 X25:235 Y10:195 P9 ; Define mesh grid for probing
```

BLTouch v3.1

- **!!** In addition to the changes in the config.g file, you will need to add two simple files in your /sys/ folder.

✕ 0:/sys/deployprobe.g

```
; deployprobe.g  
; called to deploy a physical Z probe  
;  
M280 P0 S10 ; deploy BLTouch
```

✕ 0:/sys/retractprobe.g

```
; retractprobe.g  
; called to retract a physical Z probe  
;  
M280 P0 S90 ; retract BLTouch
```

BLTouch v3.1

BLTouch – Smart **V3.1**

BLTouch Instruction	Center Of PWM (Available PWM Range ± 20)	G-code		
		Marlin / Duet	Repetier	x: Servo Pin or No.
Push-pin Down (deploy)	647 μs (10°)	M280 Px S10	M340 Px S647	M280 S3.24
Alarm Release & Touch SW Mode(M119)	1162 μs (60°)	M280 Px S60	M340 Px S1162	M280 S5.81
Push-pin Up (Stow)	1473 μs (90°)	M280 Px S90	M340 Px S1473	M280 S7.36
Self-test (10 Times)	1782 μs (120°)	M280 Px S120	M340 Px S1782	M280 S8.9
EEPROM Conversion Request	1884 μs (130°)	M280 Px S130	M340 Px S1884	M280 S9.42
EEPROM::5V Logic Zmin <i>(Do not activate on 3.3V logic system)</i>	1988 μs (140°)	M280 Px S140	M340 Px S1988	M280 S9.94
EEPROM::Logic voltage Free Zmin (Return to default: Open Drain)	2091 μs (150°)	M280 Px S150	M340 Px S2091	M280 S10.45
Alarm Release & Push-pin UP	2194 μs (160°)	M280 Px S160	M340 Px S2194	M280 S10.97

⊗ Depending on your board, you can need to adjust the PWM range or Duty cycle.

⊗ EEPROM::5V Logic Zmin: Used with 130° when the Z probe input pin on the control board is not pull-up or has an abnormal input circuit.
 ↳ see Logic Voltage Conversion

